

NEOLITH[®] TECHNICAL MANUAL

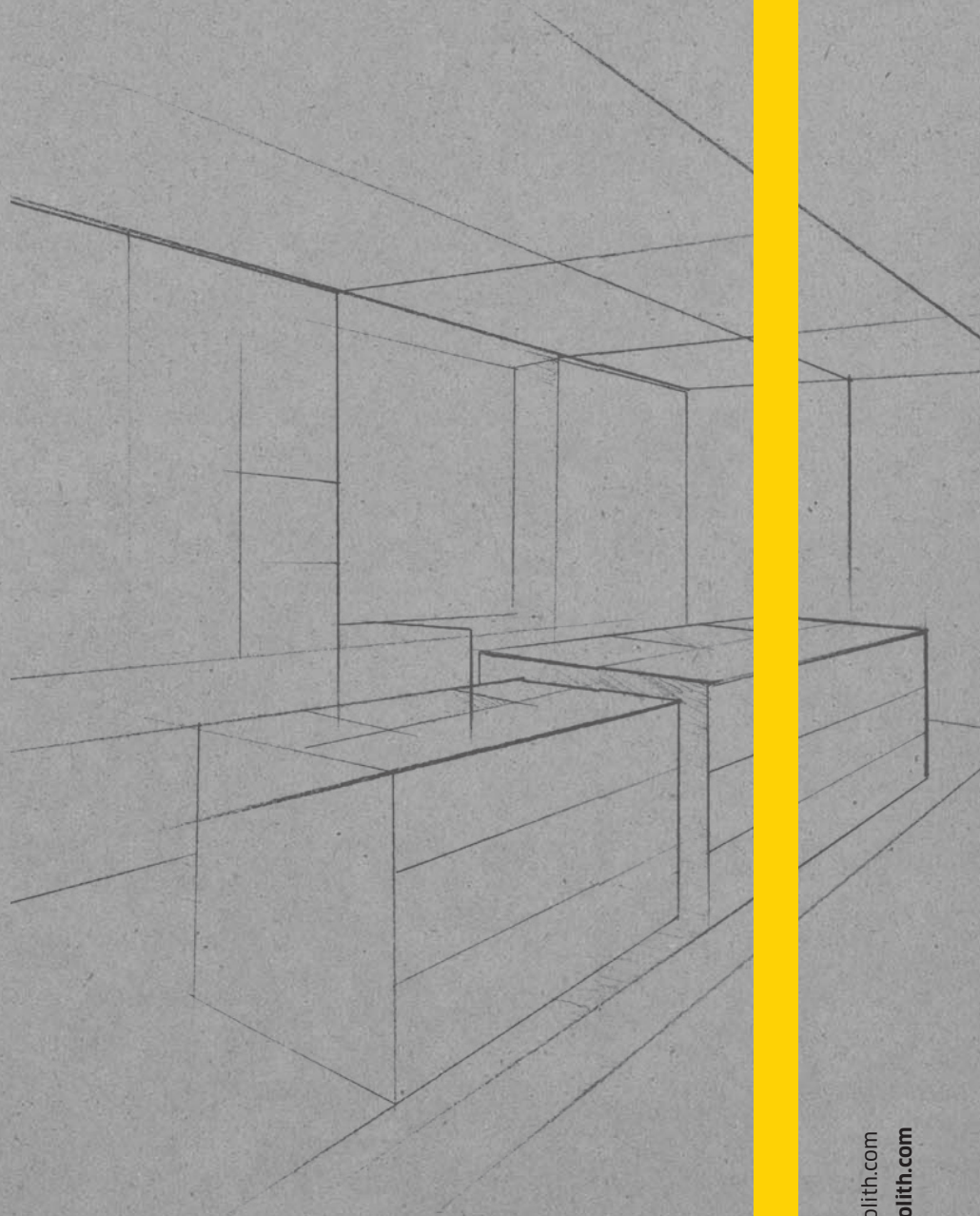

DESIGN, HANDLING AND MECHANIZATION
KITCHEN COUNTERTOPS

info@neolith.com
www.neolith.com

INDEX

01. Product	12
02. Handling and Storage	20
03. Inspection	29
04. Mechanization Parameters	32
05. Cutting Recommendations	36
06. Design and Production of a Neolith Countertop	44
07. Extreme Heat	60
08. Glue	64
09. Tiling and Paving	66
10. Repairs	69
11. Protective edges & Profiles	73
12. Tools	85
13. Cleaning Products	96

/// IMPORTANT FABRICATION INFORMATION

Natural stone and Neolith slabs are not hazardous as shipped and used by the end customer. However, fabrication and processing of materials containing quartz (ie. cutting, sawing, grinding, breaking, crushing, drilling, sanding or sculpting) generates dust which contains crystalline silica (quartz). Unprotected and uncontrolled exposure to such dust is dangerous to health and can cause severe illnesses (such as silicosis, lung cancer, fibrosis of the lungs, tuberculosis, rheumatoid arthritis, autoimmune diseases, lupus erythematosus, kidney diseases, abrasion of the cornea and irritation of the skin and eyes). Pre-existing physical disorders may aggravate the adverse effects of exposure to silica dust. Wherever this product is fabricated and processed, a silica control program shall be in place in accordance with all the applicable laws, regulations, orders and directives. The permissible exposure limits to silica dust shall also be met. For relevant information you may also look at the requirements of your Australian local workplace safety regulator, International Labour Organization (<http://www.ilo.org/safework>), the Occupational Safety & Health Administration (www.osha.gov), and the European Network for Silica (www.nepsi.eu).

FIRST AID: If irritation of the eyes or skin is experienced, flush the area immediately with plenty of water. If breathing difficulties are experienced, move outdoors into fresh air. In any event of physical discomfort, consult with a physician.

DANGER - REFER TO SAFETY DATA SHEET FOR MATERIAL BEING PROCESSED BEFORE USE



Harmful by inhalation
Danger of serious damage to health by prolonged exposure
May cause cancer (inhalation)
Causes damage to lungs through prolonged or repeated exposure (inhalation)
May cause respiratory tract irritation

Wear appropriate respiratory protection. The minimum class of respiratory protective equipment (RPE) is specified in the SDS for the material being processed, by guidance material produced by Work Health and Safety Regulators in their respective jurisdictions and by Australian Standard/New Zealand Standard AS/NZS 1715

Do not breathe or expose others to dusts generated
Wash hands and face thoroughly after handling
Do not eat, drink or smoke when using this product
Wear protective gloves/protective clothing/eye protection
Dispose of residues in accordance with local regulations
Get medical advice/attention if you feel unwell



1. IDENTIFICATION OF THE MATERIAL AND SUPPLIER

1.1 Product identifier

Product name NEOLITH SLABS OR TILES (GRES PORCELAIN)
Synonyms GLAZED / UNGLAZED CERAMIC • SINTERED COMPACT SURFACE

1.2 Uses and uses advised against

Uses BENCHTOPS • BUILDING MATERIAL • CLADDING • CONSTRUCTION MATERIAL • INDUSTRIAL APPLICATIONS • TILE
 Building Facades

1.3 Details of the supplier of the product

Supplier name CDK STONE PTY LTD
Address 4 - 6 Freighter Rd, Moorabbin, VIC, 3189, AUSTRALIA
Telephone 03 8552 6000
Fax 03 8552 6001
Email help@cdkstone.com.au
Website www.cdkstone.com.au

1.4 Emergency telephone numbers

Emergency 13 11 26

2. HAZARDS IDENTIFICATION

2.1 Classification of the substance or mixture

NOT CLASSIFIED AS HAZARDOUS ACCORDING TO SAFE WORK AUSTRALIA CRITERIA

2.2 GHS Label elements

No signal word, pictograms, hazard or precautionary statements have been allocated.

2.3 Other hazards

The solid product as supplied is classified as non-hazardous under normal conditions and does not present an inhalation, ingestion, skin, or eye hazard. However, dust created when the product is cut, grinded or machined may cause mechanical irritation and may contain crystalline silica, some of which may be respirable. Chronic exposure to respirable crystalline silica dust may cause lung fibrosis (silicosis).

3. COMPOSITION/ INFORMATION ON INGREDIENTS

3.1 Substances / Mixtures

Ingredient	CAS Number	EC Number	Content
ADDITIVE(S)	-	-	Remainder
QUARTZ (CRYSTALLINE SILICA)	14808-60-7	238-878-4	25%
NATURAL PIGMENT(S)	-	-	<1%
NATURAL CLAY	-	-	Not Available
NATURAL MINERAL(S)	-	-	Not Available

Ingredient Notes This product contains respirable quartz at a concentration of 0.1 mg/m³.

4. FIRST AID MEASURES

4.1 Description of first aid measures

Eye	(Dust exposure) Flush gently with running water, irrigating under eyelids. Seek medical attention if irritation develops.
Inhalation	(Dust exposure) If inhaled remove from contaminated area. Apply artificial respiration if not breathing.
Skin	(Dust exposure) Gently flush affected areas with water. Seek medical attention if irritation develops.
Ingestion	Due to product form and application, ingestion is considered unlikely.
First aid facilities	Eye wash facilities and safety shower are recommended.

4.2 Most important symptoms and effects, both acute and delayed

See Section 11 for more detailed information on health effects and symptoms.

4.3 Immediate medical attention and special treatment needed

Treat symptomatically.

5. FIRE FIGHTING MEASURES

5.1 Extinguishing media

Use an extinguishing agent suitable for the surrounding fire.

5.2 Special hazards arising from the substance or mixture

Non flammable. May evolve toxic gases if strongly heated.

5.3 Advice for firefighters

No fire or explosion hazard exists.

5.4 Hazchem code

None allocated.

6. ACCIDENTAL RELEASE MEASURES

6.1 Personal precautions, protective equipment and emergency procedures

Wear Personal Protective Equipment (PPE) as detailed in section 8 of the SDS.

6.2 Environmental precautions

Prevent product from entering drains and waterways.

6.3 Methods of cleaning up

If spilt, collect and reuse where possible.

6.4 Reference to other sections

See Sections 8 and 13 for exposure controls and disposal.

7. HANDLING AND STORAGE

7.1 Precautions for safe handling

Before use carefully read the product label. Use of safe work practices are recommended to avoid eye or skin contact and inhalation. Observe good personal hygiene, including washing hands before eating. Prohibit eating, drinking and smoking in contaminated areas.

7.2 Conditions for safe storage, including any incompatibilities

Ensure material is adequately labelled and protected from physical damage.

7.3 Specific end uses

No information provided.

8. EXPOSURE CONTROLS / PERSONAL PROTECTION

8.1 Control parameters

Exposure standards

Ingredient	Reference	TWA		STEL	
		ppm	mg/m ³	ppm	mg/m ³
Quartz (respirable dust)	SWA [AUS]	--	0.1	--	--

Biological limits

No biological limit values have been entered for this product.

8.2 Exposure controls

Engineering controls

Avoid inhalation. Use in well ventilated areas. Where an inhalation risk exists, mechanical extraction ventilation is recommended. Wet where possible. Maintain dust levels below the recommended exposure standard.

PPE

- Eye / Face** If cutting or sanding with potential for dust generation, wear dust-proof goggles.
- Hands** Wear leather or cotton gloves.
- Body** Not required under normal conditions of use.
- Respiratory** If cutting or sanding with potential for dust generation, wear a Class P1 (Particulate) respirator.



9. PHYSICAL AND CHEMICAL PROPERTIES

9.1 Information on basic physical and chemical properties

Appearance	SOLID
Odour	ODOURLESS
Flammability	NON FLAMMABLE
Flash point	NOT RELEVANT
Boiling point	2230°C
Melting point	1610°C
Evaporation rate	NOT AVAILABLE
pH	NOT AVAILABLE
Vapour density	NOT AVAILABLE
Specific gravity	2.5
Solubility (water)	INSOLUBLE
Vapour pressure	NOT AVAILABLE
Upper explosion limit	NOT RELEVANT
Lower explosion limit	NOT RELEVANT
Partition coefficient	NOT AVAILABLE
Autoignition temperature	NOT AVAILABLE
Decomposition temperature	NOT AVAILABLE
Viscosity	NOT AVAILABLE
Explosive properties	NOT AVAILABLE
Oxidising properties	NOT AVAILABLE
Odour threshold	NOT AVAILABLE

10. STABILITY AND REACTIVITY

10.1 Reactivity

Carefully review all information provided in sections 10.2 to 10.6.

10.2 Chemical stability

Stable under recommended conditions of storage.

PRODUCT NAME NEOLITH SLABS OR TILES (GRES PORCELAIN)

10.3 Possibility of hazardous reactions

Polymerization is not expected to occur.

10.4 Conditions to avoid

Avoid heat, sparks, open flames and other ignition sources.

10.5 Incompatible materials

Incompatible with strong acids (e.g. hydrofluoric acid).

10.6 Hazardous decomposition products

May evolve toxic gases if heated to decomposition.

11. TOXICOLOGICAL INFORMATION

11.1 Information on toxicological effects

Acute toxicity	This product is expected to be of low toxicity. Ingestion is considered unlikely due to product form.
Skin	Mechanical irritant. Prolonged or repeated contact may result in mild irritation due to mechanical action.
Eye	Mechanical irritant. Due to product form and nature of use, the potential for exposure is reduced. Product may only present a hazard if material is cut, drilled or sanded with dust generation, which may result in mechanical irritation.
Sensitisation	Not classified as causing skin or respiratory sensitisation.
Mutagenicity	Not classified as a mutagen.
Carcinogenicity	Adverse health effects, usually associated with long term exposure to high respirable crystalline silica quartz dust levels are not anticipated due to product form. This product may only present a hazard if rocks are cut or drilled with dust generation. Respirable crystalline silica quartz is classified as carcinogenic to humans (IARC Group 1).
Reproductive	Not classified as a reproductive toxin.
STOT - single exposure	Dust can be generated during cutting of the product. Dusts are mechanical irritants that may cause throat irritation.
STOT - repeated exposure	Adverse health effects, usually associated with long term exposure to high respirable crystalline silica quartz dust levels are not anticipated due to the product form. This product may only present a hazard if rocks are cut or drilled with dust generation. Chronic exposure to dust may cause lung fibrosis (silicosis).
Aspiration	Not applicable for solids.

12. ECOLOGICAL INFORMATION

12.1 Toxicity

The substance is inert there is no evidence of significant toxicity.

12.2 Persistence and degradability

Being inorganic, the substance will not biodegrade.

12.3 Bioaccumulative potential

The substance is inert and will not be absorbed and accumulate in tissues.

12.4 Mobility in soil

No information provided.

12.5 Other adverse effects

The main component/s of this product are not anticipated to cause any adverse effects to plants or animals.

13. DISPOSAL CONSIDERATIONS

13.1 Waste treatment methods

Waste disposal	Reuse where possible. Dispose of in accordance with local regulations.
Legislation	Dispose of in accordance with relevant local legislation.

14. TRANSPORT INFORMATION

NOT CLASSIFIED AS A DANGEROUS GOOD BY THE CRITERIA OF THE ADG CODE, IMDG OR IATA

	LAND TRANSPORT (ADG)	SEA TRANSPORT (IMDG / IMO)	AIR TRANSPORT (IATA / ICAO)
14.1 UN Number	None allocated.	None allocated.	None allocated.
14.2 Proper Shipping Name	None allocated.	None allocated.	None allocated.
14.3 Transport hazard class	None allocated.	None allocated.	None allocated.
14.4 Packing Group	None allocated.	None allocated.	None allocated.

14.5 Environmental hazards

No information provided.

14.6 Special precautions for user

Hazchem code None allocated.

15. REGULATORY INFORMATION

15.1 Safety, health and environmental regulations/legislation specific for the substance or mixture

Poison schedule A poison schedule number has not been allocated to this product using the criteria in the Standard for the Uniform Scheduling of Medicines and Poisons (SUSMP).

Classifications Safework Australia criteria is based on the Globally Harmonised System (GHS) of Classification and Labelling of Chemicals.

Inventory listings **AUSTRALIA: AICS (Australian Inventory of Chemical Substances)**
All components are listed on AICS, or are exempt.

16. OTHER INFORMATION

Additional information **PERSONAL PROTECTIVE EQUIPMENT GUIDELINES:**
The recommendation for protective equipment contained within this report is provided as a guide only. Factors such as form of product, method of application, working environment, quantity used, product concentration and the availability of engineering controls should be considered before final selection of personal protective equipment is made.

HEALTH EFFECTS FROM EXPOSURE:
It should be noted that the effects from exposure to this product will depend on several factors including: form of product; frequency and duration of use; quantity used; effectiveness of control measures; protective equipment used and method of application. Given that it is impractical to prepare a report which would encompass all possible scenarios, it is anticipated that users will assess the risks and apply control methods where appropriate.

PRODUCT NAME NEOLITH SLABS OR TILES (GRES PORCELAIN)**Abbreviations**

ACGIH	American Conference of Governmental Industrial Hygienists
CAS #	Chemical Abstract Service number - used to uniquely identify chemical compounds
CNS	Central Nervous System
EC No.	EC No - European Community Number
EMS	Emergency Schedules (Emergency Procedures for Ships Carrying Dangerous Goods)
GHS	Globally Harmonized System
GTEPG	Group Text Emergency Procedure Guide
IARC	International Agency for Research on Cancer
LC50	Lethal Concentration, 50% / Median Lethal Concentration
LD50	Lethal Dose, 50% / Median Lethal Dose
mg/m ³	Milligrams per Cubic Metre
OEL	Occupational Exposure Limit
pH	relates to hydrogen ion concentration using a scale of 0 (high acidic) to 14 (highly alkaline).
ppm	Parts Per Million
STEL	Short-Term Exposure Limit
STOT-RE	Specific target organ toxicity (repeated exposure)
STOT-SE	Specific target organ toxicity (single exposure)
SUSMP	Standard for the Uniform Scheduling of Medicines and Poisons
SWA	Safe Work Australia
TLV	Threshold Limit Value
TWA	Time Weighted Average

Report status

This document has been compiled by RMT on behalf of the manufacturer, importer or supplier of the product and serves as their Safety Data Sheet ('SDS').

It is based on information concerning the product which has been provided to RMT by the manufacturer, importer or supplier or obtained from third party sources and is believed to represent the current state of knowledge as to the appropriate safety and handling precautions for the product at the time of issue. Further clarification regarding any aspect of the product should be obtained directly from the manufacturer, importer or supplier.

While RMT has taken all due care to include accurate and up-to-date information in this SDS, it does not provide any warranty as to accuracy or completeness. As far as lawfully possible, RMT accepts no liability for any loss, injury or damage (including consequential loss) which may be suffered or incurred by any person as a consequence of their reliance on the information contained in this SDS.

Prepared by

Risk Management Technologies
5 Ventnor Ave, West Perth
Western Australia 6005
Phone: +61 8 9322 1711
Fax: +61 8 9322 1794
Email: info@rmt.com.au
Web: www.rmtglobal.com

[End of SDS]

01. PRODUCT

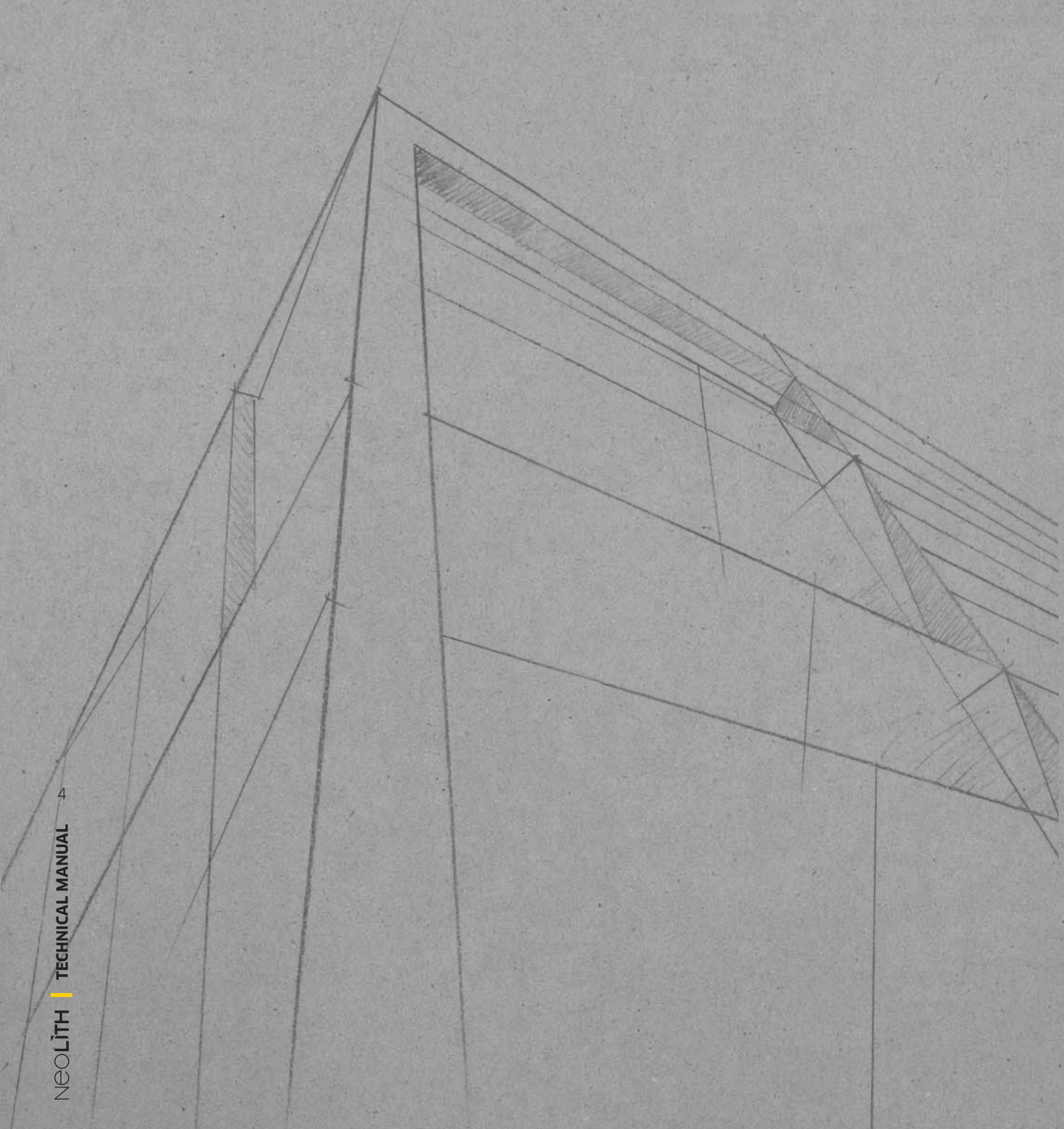

01. PRODUCT

1.1 Product Range



Arctic White



Arena

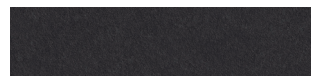

Nero Zimbabwe



Avorio



Barro



Phedra



Humo

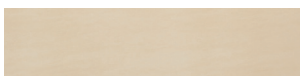

Basalt Beige



Pierre Bleue



Nero



Basalt Black

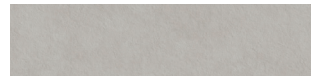

Pietra di Luna

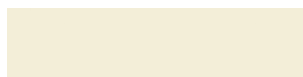

Nieve

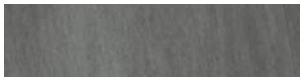

Basalt Grey

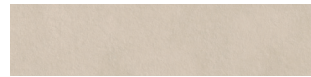

Pietra di Osso



Perla



Beton



Pietra di Piombo



Just White



Cement



Zaha Stone



Lava



Krater



Aspen Grey

01. PRODUCT

1.1 Product Range



Sofia Cuprum



Mirage

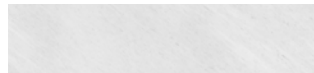

Blanco Carrara



Iron Copper

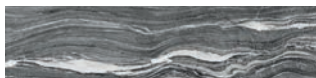

Mar del Plata



Calacatta



Iron Corten



New York - New York



Calacatta Gold



Iron Frost



Retrostone



Calacatta Gold



Iron Grey



Mont Blanc

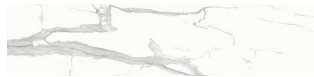

Estuario E01/E01R



Iron Moss



Strata Argentum



Estuario E05/E05R



La Bohème B01

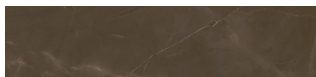

Pulpis



Nero Marquina

01. PRODUCT

1.2 Finishes



SATIN

Completely matte finish. Highly resistant and ideal for commercial uses.



SILK

A matte finish with a light layer of enamel for subtle shine and a pleasant soft touch. Surface finish which is easy to clean.



RIVERWASHED

Finish with a rugged texture and high relief for surfaces that evoke feelings upon touch.

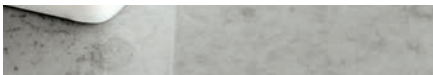

DÉCOR POLISHED

Décor Polished offers a perfectly linear reflection of the Classtone Collection colors, which gain depth and elegance.



NANOTECH POLISHED

With a high shine level, Nanotech Polished offers the Colorfeel Collection a more sophisticated image.

1.2.1 Special Finishes

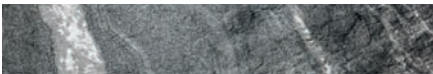

SLATE FINISH

Available now in the Mar del Plata, Slate finish creates the delusion of stratum on the surface.



BOHÈME

You have to touch La Bohème to believe it. A natural relief that reminds the touch of a Lebanese cedar of a hundred years.

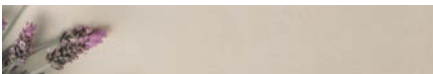

NATURAL HONED

Honed texture typical of natural stones: flat, soft, without any glossiness and completely matte.



ULTRASOFT

Texture with a greater degree of softness and depth than Natural Honed. Available in Calacatta Luxe model and on request in Calacatta, Calacatta Gold and Estatuario.



STEEL TOUCH

The semi-polished finish on these stones creates an irregular, burnished effect which gives the surface a more worn-in touch and feel.

01. PRODUCT

1.3 Formats

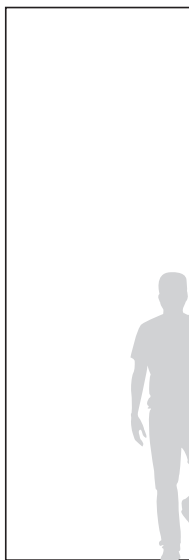

3.600x1.200 mm
142"x48"



3.200x1.500 mm
126"x60"

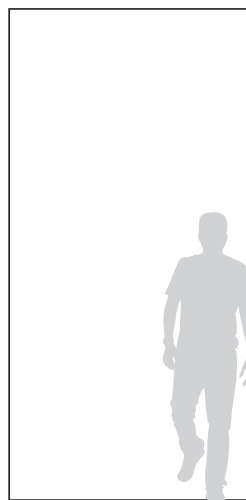

3.200x1.600 mm
126"x64"



2.600x1.200 mm
102"x48"



2.600x1.500 mm
*102"x60" *

The measures above are **net measures**. Please note that unless it is specified in the order, the slabs will be delivered in **gross measure** (eg: 3.250x1.550mm instead of 3.200x1.500mm) in order to prevent any type of break in the peaks during transport and logistics affect the usable net measure of the table.

* This format is only available for projects. Not in permanent stock. Please ask for minimum quantities.

01. PRODUCT

1.4 Thicknesses

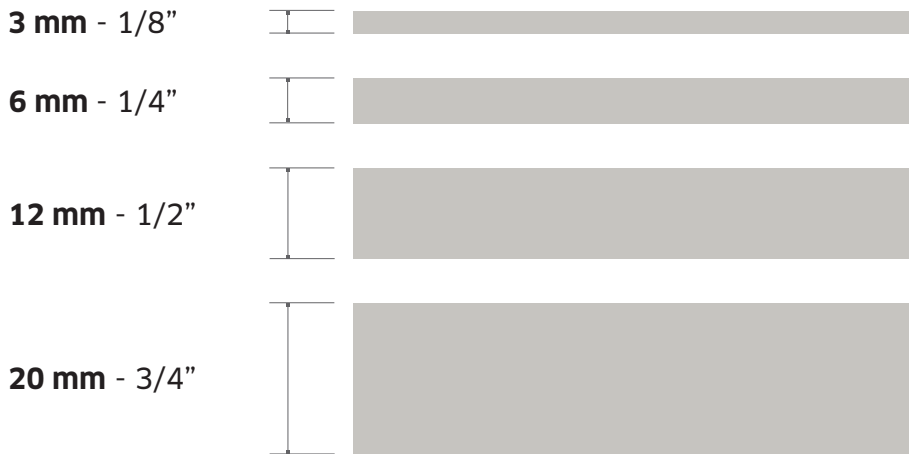

	3 (1/8")	3+ (1/8")	6 (1/4")	6+ (1/4")	12 (1/2")	20 (3/4")
Indoor paneling	•	•	•	•		
Indoor paving			•	•		•
Outdoor natural stone facade			•	•	•	
Outdoor paving			•	•		•
Ventilated facade with exposed anchor				•	•	
Ventilated facade with hidden anchor				•	•	
Countertops					•	•
High-traffic paving				•	•	•
Indoor paneling over the material	•	•	•	•		
Indoor paving over the material			•	•		
Furniture	•	•	•	•	•	

TEST	ASTM	Unit	FINISH			
			SATIN	SILK	POLISHED	RIVERWASHED
Moisture expansion	ASTM C370-12 (2016)	%	<0,1%	<0,1%	<0,1%	<0,1%
Linear Thermal expansion	ASTM C372-94 (2016)	($\times 10^{-6}$) °C ⁻¹	5,7	5,8	5,3	6,1
Water absorption	ASTM C373-16	%	<0,1%	<0,1%	<0,1%	<0,1%
Crazing resistance	ASTM C424-93 (2016)	-	OK	OK	OK	OK
Thermal Shock resistance	ASTM C484-99 (2014)	-	OK	OK	OK	OK
Chemical resistance	ASTM C650-04 (2014)	-	OK	OK	OK	OK
Visible abrasion	ASTM C1027-09	Class	*PTR	Class 3	Class 5	*PTR
Deep abrasion	ASTM C1243-93 (2015)	mm ³	112	*PTR	*PTR	*PTR
Stain resistance	ASTM C1378 (2014)	Class	A	A	A	A

TEST	NORM	DETERMINATION	Unit	FINISH			
				SATIN	SILK	POLISHED	RIVERW.
Determination of Dimensions and Surface Quality	ISO-10545-2	Thickness *	mm	± 0,2	± 0,2	± 0,2	± 0,2
		Flatness Tolerance Width Slab	mm	± 2 (0,1%)	± 2 (0,1%)	± 2 (0,1%)	± 2 (0,1%)
		Flatness Tolerance Length Slab	mm	± 4 (0,1%)	± 4 (0,1%)	± 4 (0,1%)	± 4 (0,1%)
		Dimension Tolerance	mm	± 1 (0,2%)	± 1 (0,2%)	± 1 (0,2%)	± 1 (0,2%)
Water Absorption Capacity	ISO-10545-3	Absorption by Boiling	%	≤ 0,1	≤ 0,1	≤ 0,1	≤ 0,1
		Density	gr/cm ³	2,4	2,4	2,4	2,4
Impact Resistance	ISO-10545-5	Coefficient of Restitution	-	0,84	0,83	0,83	0,83
Resistance to Deep Abrasion	ISO-10545-6	Lost Volume	mm ³	112	-	-	-
Resistance to Superficial Abrasion	ISO-10545-7	Visual Control	Class	PEI III	PEI II	PEI I	PEI II
Linear Thermal Expansion	ISO-10545-8	Expansion 25 - 100°C (Average)	10 ⁻⁶ . °C	5,7	5,7	5,7	5,7
Thermal Shock	ISO-10545-9	Damage	-	No Damage	No Damage	No Damage	No Damage
Moisture Expansion	ISO-10545-10	Coefficient of Expansion	mm/m	< 0,1	< 0,1	< 0,1	< 0,1
Frost Resistance	ISO-10545-12	Damage	-	No Damage	No Damage	No Damage	No Damage
Chemical Resistance	ISO-10545-13	Cleaning Products	Class	UA	GA	GA	GA
		Swimming Pool Salts	Class	UA	GA	GA	GA
		Low Concentration Acids and Bases	Class	ULA	GLA	GLB	GLA
		High Concentration Acids and Bases	Class	UHA	GHA	GHB	GHA
Stain Resistance	ISO-10545-14	Visual Control	Class	5	5	5	5
Lead and Cadmium Release	ISO-10545-15	Lead Concentration	mg/dm ²	<0,01	<0,01	<0,01	<0,01
		Cadmium Concentration	mg/dm ²	<0,001	<0,001	<0,001	<0,001
UV Resistance	DIN 51094	Color Change	-	No Change	No Change	No Change	No Change
Anti-Slip Properties	DIN 51130	Critical Angle with footwear	Class	R9	R9	-	R10
	DIN 51097	Critical Angle Barefoot	Class	A	A	-	A
	ANSI A137.1	Dynamic Coefficient of Friction	-	0,52	0,42	0,21	0,53
	UNE-ENV 12633	Slip Resistance (Pendulum Method)	Class	2	1	0	2

01. PRODUCT

1.5 Product Technical Characteristics

Bending Resistance as per the slab thickness:

TEST	STANDARD	DETERMINATION	Unit	3600 x 1200						3200 x 1500			
				3 mm	3+	6 mm	6+	3+3	6+3	6+6	6+	12 mm	20 mm
Weight	-	Grammage	Kg/m ²	7	8	14	15	16	23	30	15	29	
		Mass		34	38	67	72	76	110	143	77	148	
Bending Resistance	ISO 10545-4	Breaking Force	N	353	430	1449	1807	1337	2735	3149	1807	5451	15748
		Modulus of Rupture	N/mm ²	48	54	48	53	47	57	47	53	51	55



02. HANDLING AND STORAGE

02. HANDLING AND STORAGE

Neolith slabs must be loaded, unloaded and transported by means of a forklift, bridge crane or other hoisting device.

Whenever handling and transporting, the slabs must be balanced taking their center of gravity into account.

The following table summarizes the weight per slab and per square meter:

Format	3600 x 1200 mm, 144" x 48"							3200 x 1500 mm, 125" x 60" 3200 x 1600 mm, 125" x 64"		
	3	3+	6	6+	3+3	6+3	6+6	6+	12	20
Thicknesses (mm)	3	3+	6	6+	3+3	6+3	6+6	6+	12	20
Weight (kg/m ²)	7	8	14	15	16	23	30	14	29	48
Weight of full slab (Kg)	34	38	67	72	76	110	143	77	148	245

Table 1: Formats and weights per thickness.

2.1 Transporting with a clamp

Always pay attention to the movement and handling of the slabs to prevent splintering or breakage.

TheSize recommends using the following type of clamp for lifting and moving individual slabs:

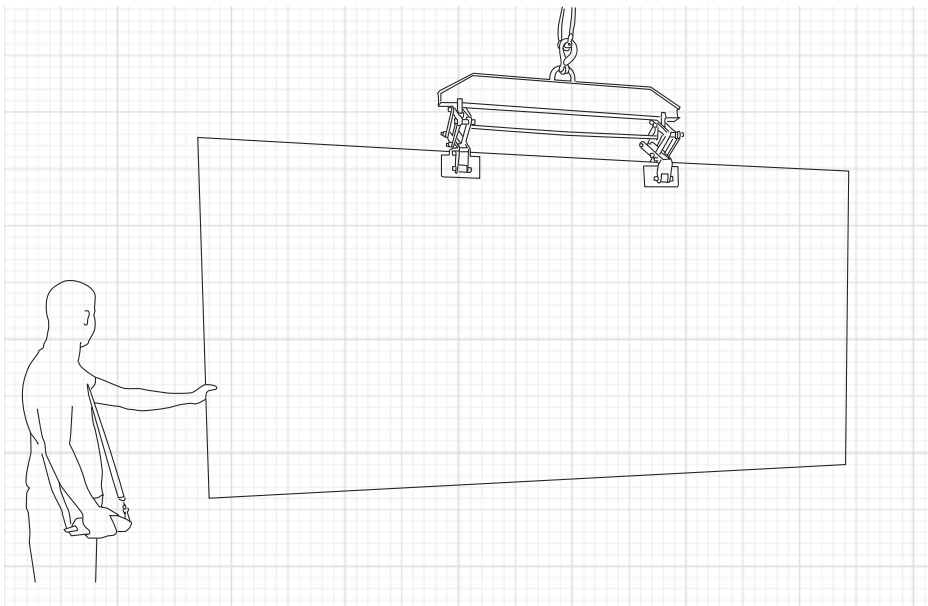

Neolith Slab handled with a clamp

The additional width of this clamp will prevent the slab from bending during handling to, thus, prevent undesirable breakage.

This clamp is available through TheSize.

Contact TheSize for more details.

Recommendations:

- Clamping more than 2 slabs at the same time is not recommended.
- Before lifting polished slabs with the clamp, remove the protective plastic.

Make sure to cover all metal surfaces that may come into contact with the slab with adhesive foam tape.



Make sure to cover all metal surfaces that may come into contact with the slab with adhesive foam tape.

If this type of clamp is not available, use a 2 cm thick plank of approximately 3 m x 20 cm so the clamp can catch 12 mm slabs.

Fixing the ends of the slab with jacks to the plank so the slab doesn't sag during handling is recommended.

Position the plank to the rear of the slab to be lifted.

- 1) Place the clamp on the slab and the plank.
- 2) Fix the clamp and lift the slab and plank with care.
- 3) Avoid sudden changes in direction.

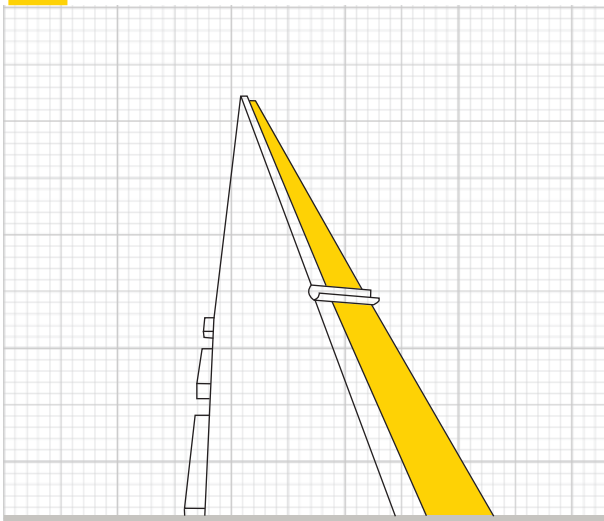

1. Plank at the back of the slab

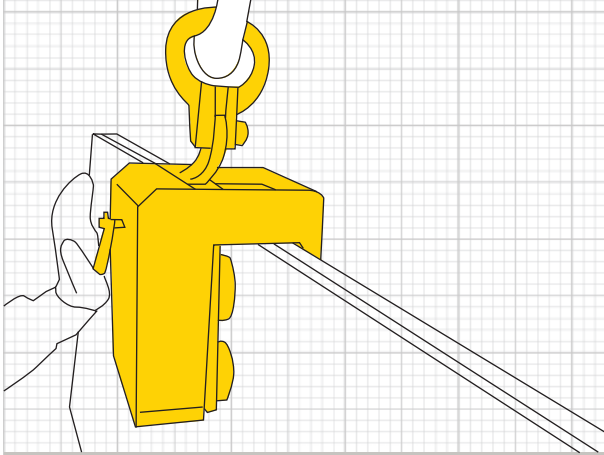

2. Clamping

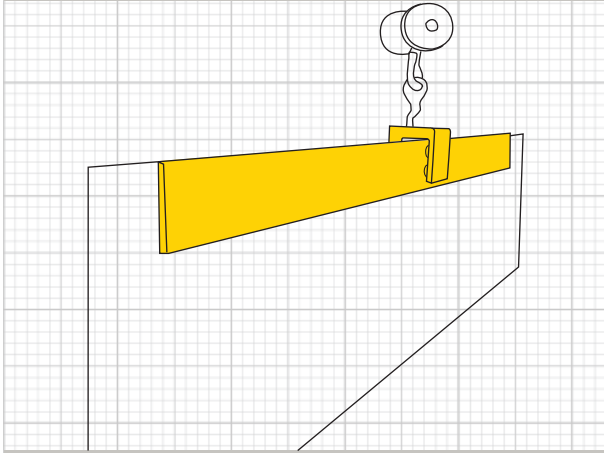

3. Handling the slab with the clamp

2.2 Transporting with slings

Using canvas slings to move several slabs at the same time is recommended.

Metal slings must not be used to handle Neolith slabs.



Canvas slings

2.3 Manually transporting a Neolith slab

Moving a Neolith countertop

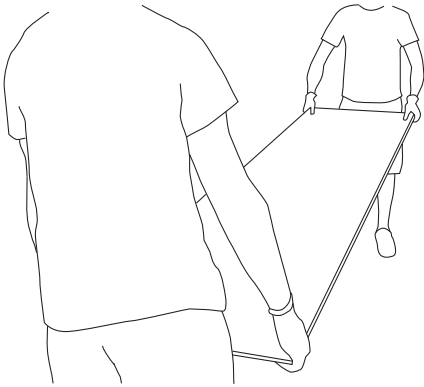

✗ INCORRECT

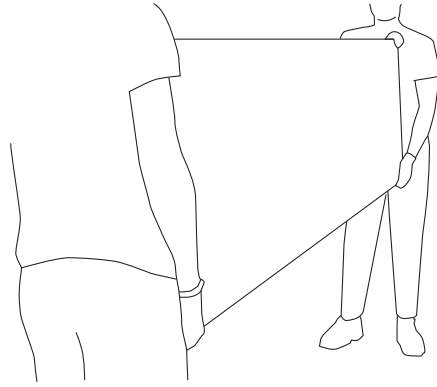

✓ CORRECT

Raising a Neolith countertop onto a bench

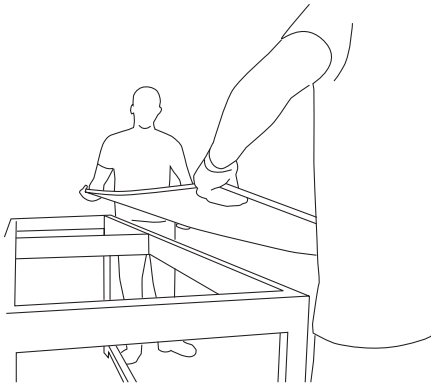

✗ INCORRECT

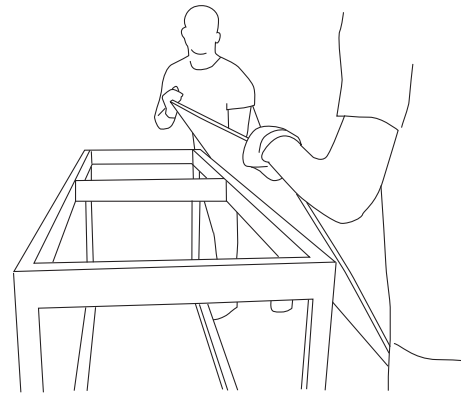

✓ CORRECT

2.4 Suction frame

For easier handling of slabs and finished parts, using a suction frame is recommended (only for 3 and 6 mm slabs).

The suction cups can move easily along the frame which helps adapt the frame to any size slab needed.

This frame can be purchased from TheSize.

*Contact TheSize for more details.

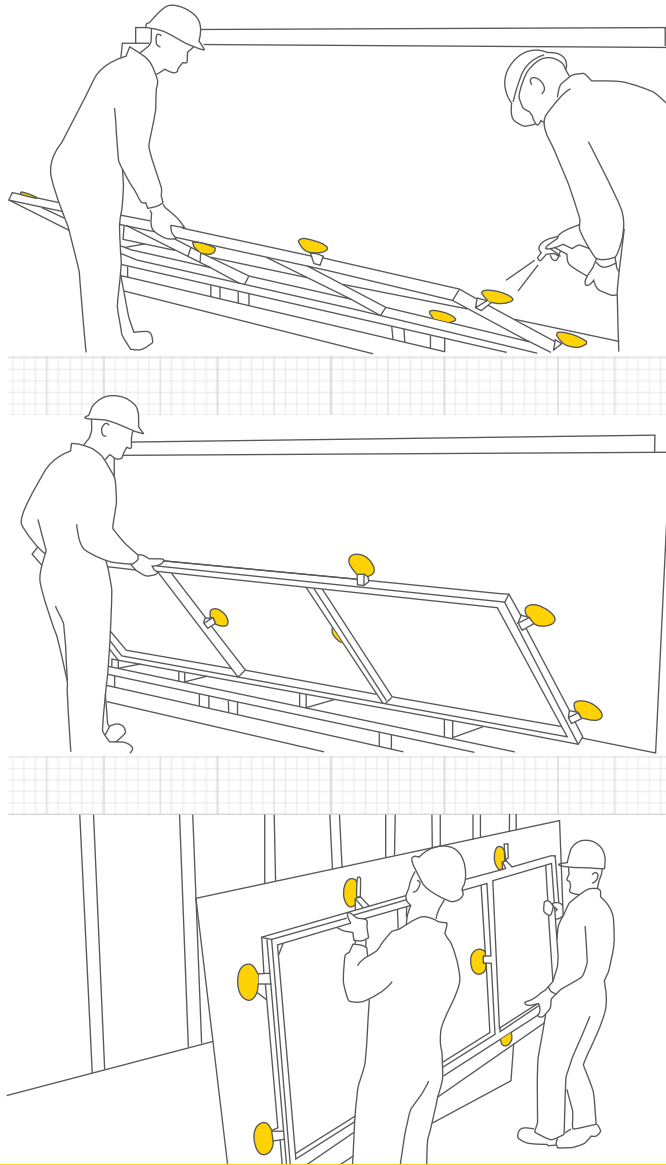

Handling and installing a piece with a suction frame

If this type of frame is not available, an aluminum rod or similar element, secured with several jacks, can also be used.

This will prevent the part from bending too much during handling.

Fixing thin, long parts (skirting, for example) with jacks to an aluminum rod for transport is also recommended.

This will prevent the part from bending too much during handling.

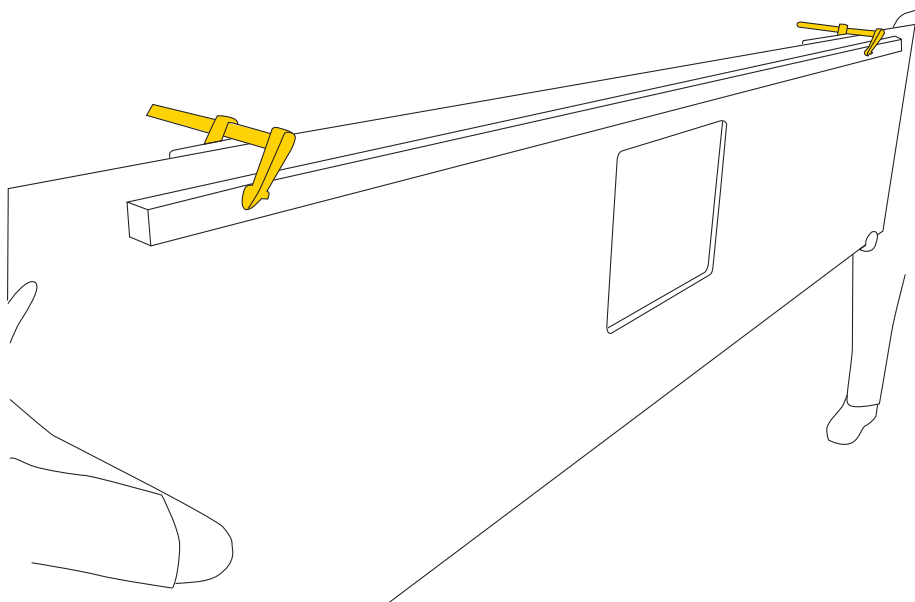

Handling a part with a rod secured with jacks

2.5 Slab storage

Place the slabs length-wise on wooden beams to prevent the slabs from splintering.



3 mm and 6 mm slabs need at least three support points, distributed evenly along the back of the slab; a full support is recommended - an unused granite or marble slab with sufficient width, for example. The best way to maintain the integrity of the slabs is to keep them in their original packaging or use a full support on the back of the slab such as an unused granite or marble slab which is wide enough.

Avoid positioning large slabs against smaller slabs:

✓ CORRECT

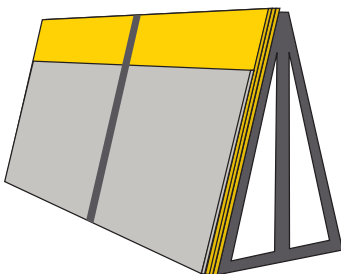

✗ INCORRECT

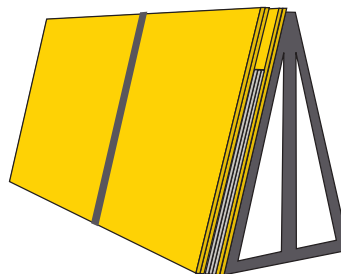

The supports must be able to hold the entire surface of the part during transport. Supports that are too small may cause the part to break:

✓ CORRECT

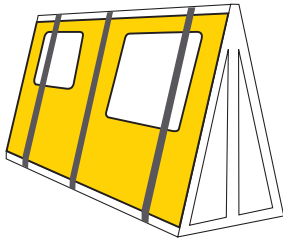

✗ INCORRECT

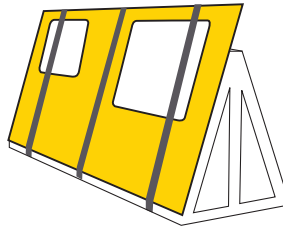

Storage of Neolith slabs in the shop

2.6 Transport by road

When in a truck, the slabs must be completely supported and securing the slabs mechanically (with jacks or belts) is recommended as they could become loose with strong wind and break.

Lightweight slabs and tiles may easily fall from a truck or to the ground so always secure the slabs to a sawhorse while unloading. Pay special attention in the shop if the slabs are stored outdoors; secure the slabs to sawhorses to protect them from gusts of wind.

03. INSPECTION

Before beginning production, TheSize recommends deep-cleaning the slab and doing a meticulous visual inspection of the slab to check whether the slab complies with the quality requirements. Check these items when visually inspecting a slab:

- Fissures
- Stains
- The tones of the different slabs
- Thickness
- Shine variations
- Flatness
- Pollution
- Pricks
- Imperfections

This should be the first step prior to starting production. Doing the inspection against the light to identify possible imperfections not seen when flat is recommended.

*No claims will be accepted for installed or manufactured material when defects were already present upon delivery of the material. Marble workers are responsible for determining whether the slabs are adequate for use. If they are not adequate, they should be exchanged before the slabs are cut or modified in any way.

3.1 Slab characteristics

3.1.1 Flatness

To check the flatness of a slab, it should be positioned horizontally on a completely flat base.

The flatness is measured by placing an aluminum rod or similar object on the surface of the slab, covering the entire width or length of the slab.



Image 9: Set-up for correct measurement of the warp.

MAXIMUM TOLERANCE IN THE SLAB WIDTH: 2 mm
MAXIMUM TOLERANCE IN THE SLAB LENGTH: 4 mm

3.1.2 Tone

TheSize is constantly working so the tone of the current batches matches the tone of previous batches. Despite our efforts, slight variations in tone may occur between different batches of the same model due to the use of natural raw materials.

Deviations in tone are more noticeable among the various thicknesses of a single model given the way in which each thickness is produced.

Before cutting, visually inspect the slabs to ensure the tone of the different slabs is acceptable. Do this inspection under lighting conditions that are similar to what would be found at the place of installation. We recommend not combining slabs from different batches.

3.2 Slab identification

Each slab has a label with important information related to each slab. The labels must be recorded for future reference.



04. MECHANIZATION PARAMETERS

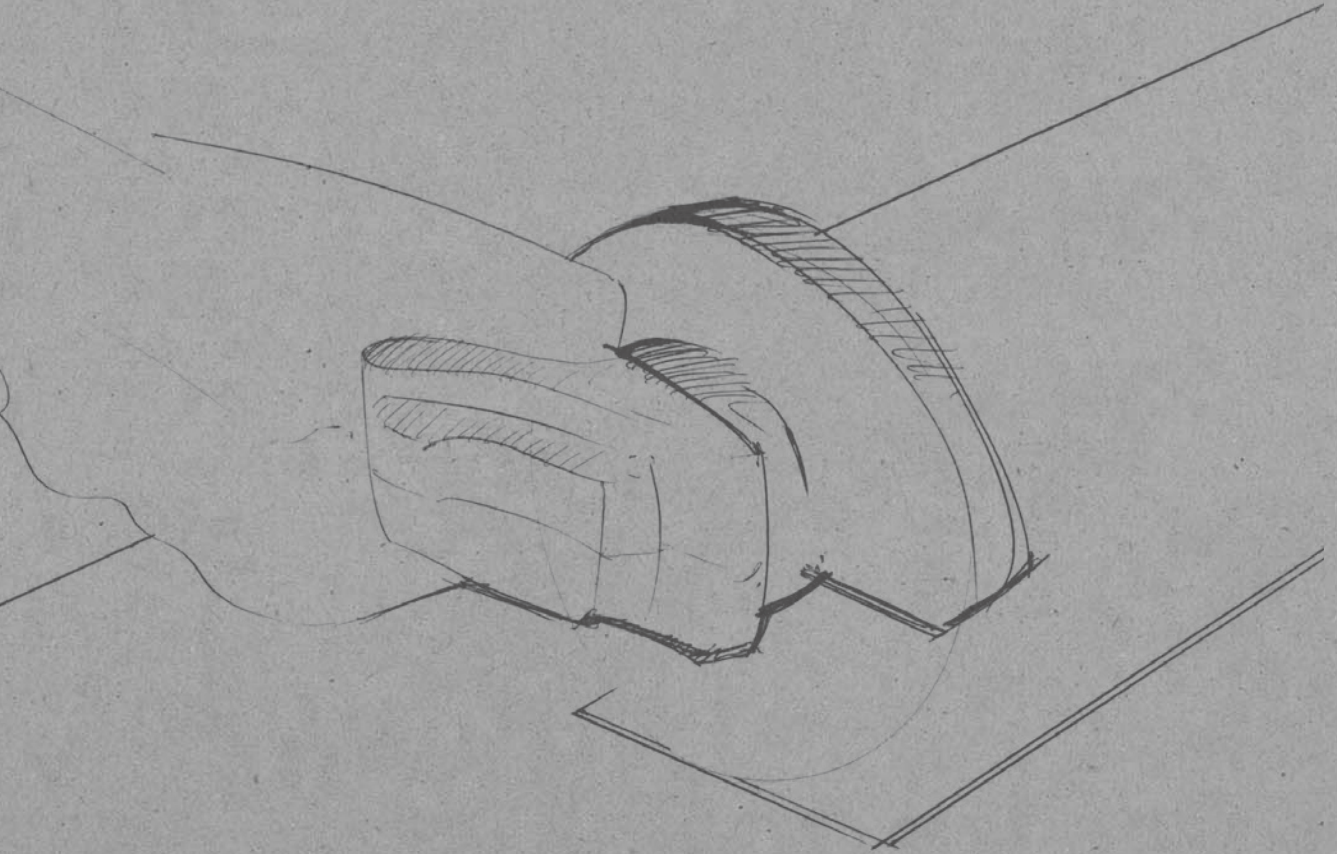

04. MECHANIZATION PARAMETERS

Before producing a 12 mm or 20 mm slab, it is important to remove 2 cm of each side from the slab:

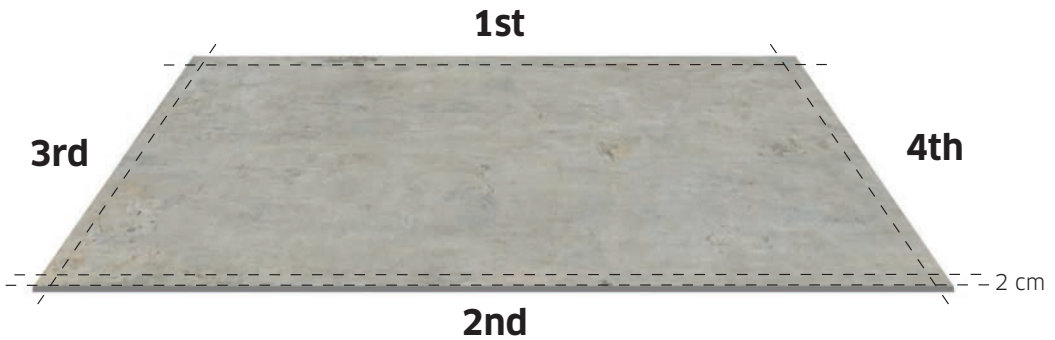

Cuts to loosen a 12 mm or 20 mm slab.

Both the 1st and 2nd cut as well as the 3rd and 4th cut must go in the same direction:

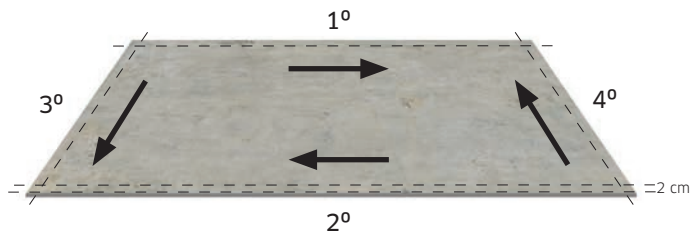

✗ INCORRECT

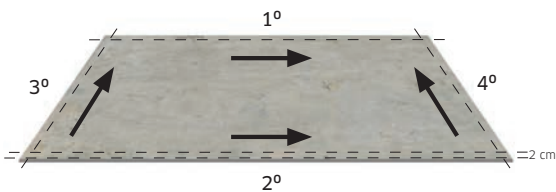

✓ CORRECT

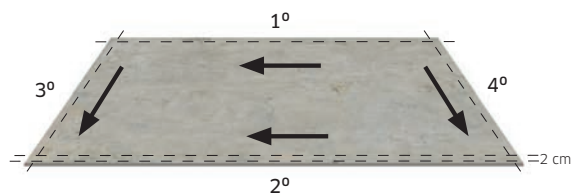

When cutting 12 mm or 20 mm slabs with a disc, it is important to reduce the speed to half at the beginning and end of the cutting process.

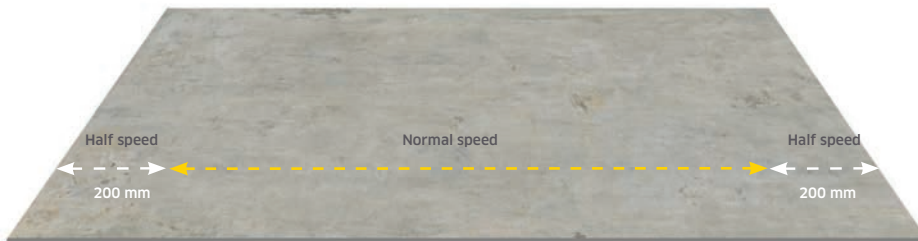

These recommendations only apply to 12 mm and 20 mm slabs.
Any other thickness can be cut without having to take these steps into account.

05. CUTTING RECOMMENDATIONS

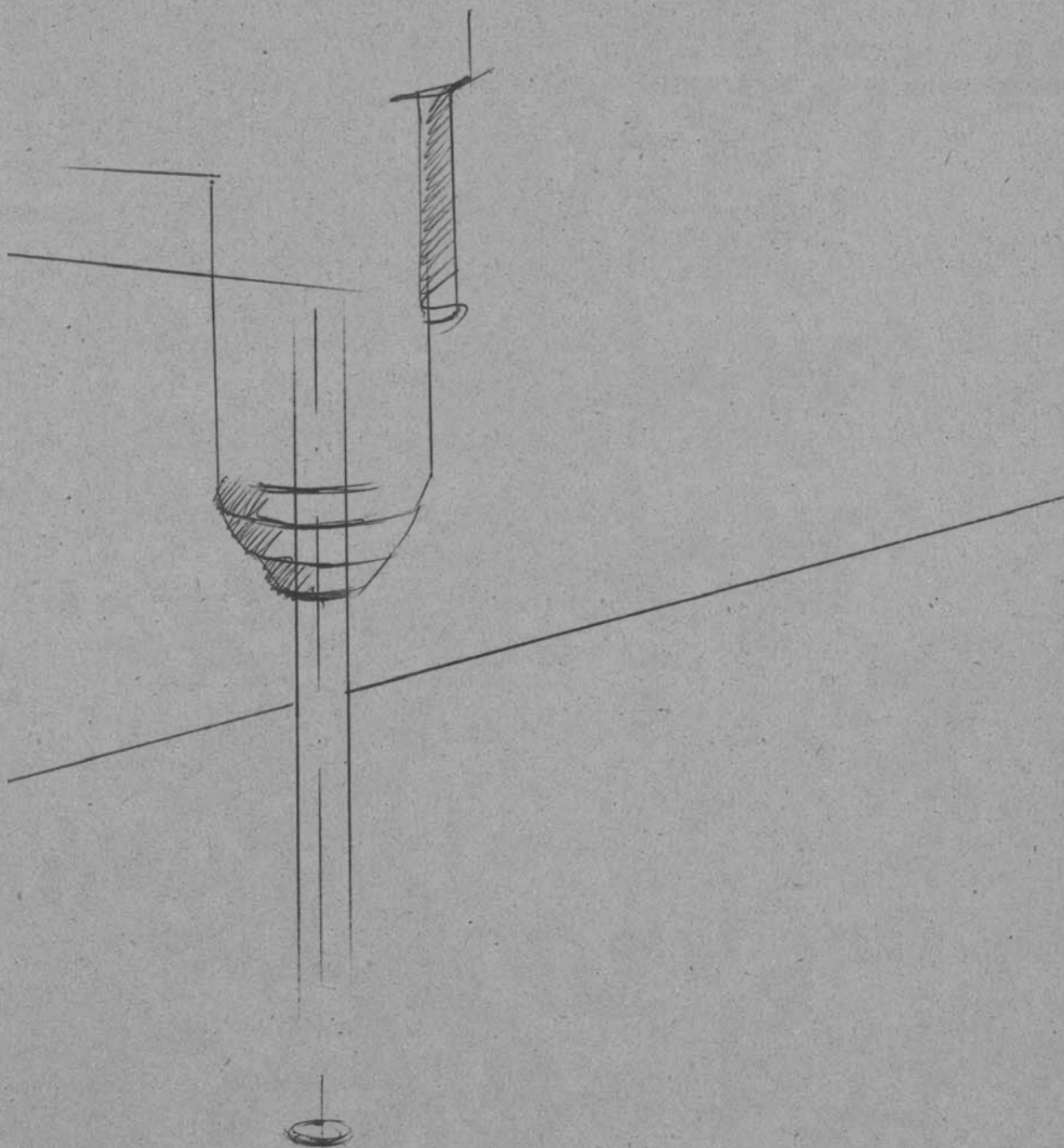

05. CUTTING RECOMMENDATIONS

5.1 Bridge disc or similar

Before beginning

Check that the bench is straight, level and free of any debris. Check that there is enough support for the slab.

While cutting, it's important to use the maximum water flow to cool the disc. Be sure the water flow is aimed at the cutting area.



✓ CORRECT



✗ INCORRECT

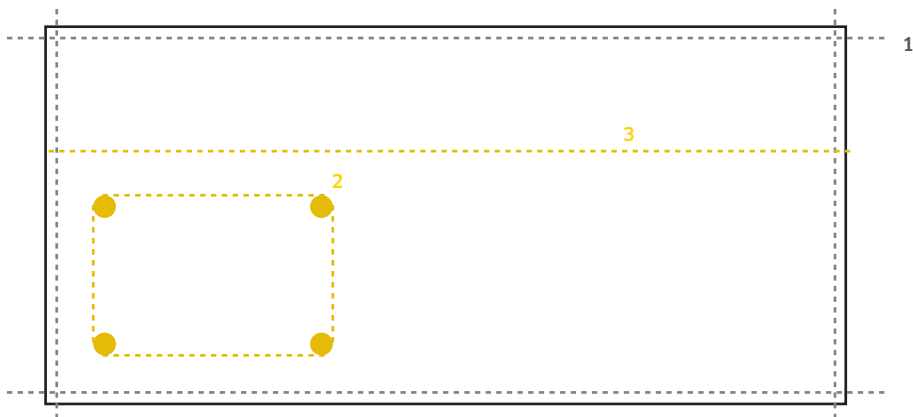

CUTTING SEQUENCE:

Steps:

1. Perimeter cut, minimum 2 cm. (only for 12 mm and 20 mm).
2. Prepare the holes on all **inner corners**, minimum 3 mm bit diameter.

We recommend bits larger than 3mm when the kitchen design allows, as it will make the countertop firmer.

3. Prepare the **remaining cuts**.



RECOMMENDATIONS:

- Make sure the disc rotation coincides with the cutting direction.
- The cutting disc should be at least 1.5 mm more than the slab thickness to guarantee a clean cut.
- To release stress, the perimeter cut of the slab may be used as a final cut for the part to be made.
- In the exceptional case that the disc is lowered directly onto the slab, do it in automatic mode at the slowest possible speed.
- Periodically check the support plates and don't use the disc if it does not easily fit into the support plate.
- Cutting 45° angles in Neolith requires a slower cutting speed. It also helps to have something at the head and tail of the cut to keep the disc aligned.
- When using a new disc, do a few cuts so the disc segments can adapt and the diamonds open.
- Use something made of limestone at the head and tail of the cut to enhance the segments if the segments become blunt faster than normal during straight cuts.

All cutouts must have previously drilled holes:

- - A minimum radius of 3 mm.
- - **Never lower the disc directly on the slab before drilling the corners.**

No squared inner corner means:

- No "L"-shaped countertop with 45° angled edges.
- No squared cutout for a sink.
- No inner 45° angled edge for the sink.
- **Absolutely NO 90° CORNER.**

- The clearest models (Arctic White, Estuario, Calacatta) are harder for tools given the specific raw materials used.

TheSize recommends lowering the cutting speeds to 75% for these models to prevent the disc from overheating.

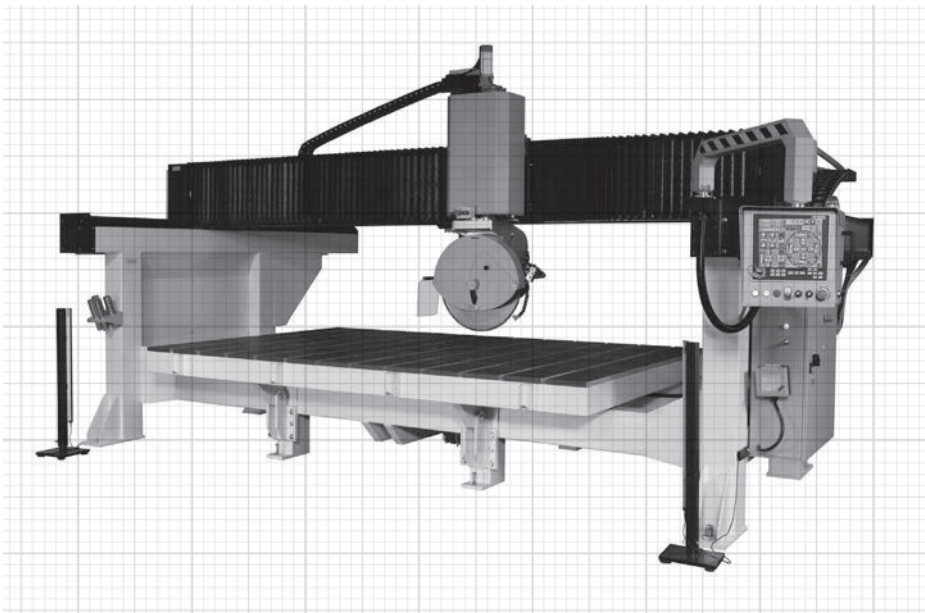

Bridge disc

5.2 Waterjet

Before beginning:

Check that the bench is straight, level and free of any debris. Check that there is enough support for the slab.

If using the waterjet to remove the 3/4" perimeters from 1/2" and 3/4" slabs, the cut should begin and go off the slab.

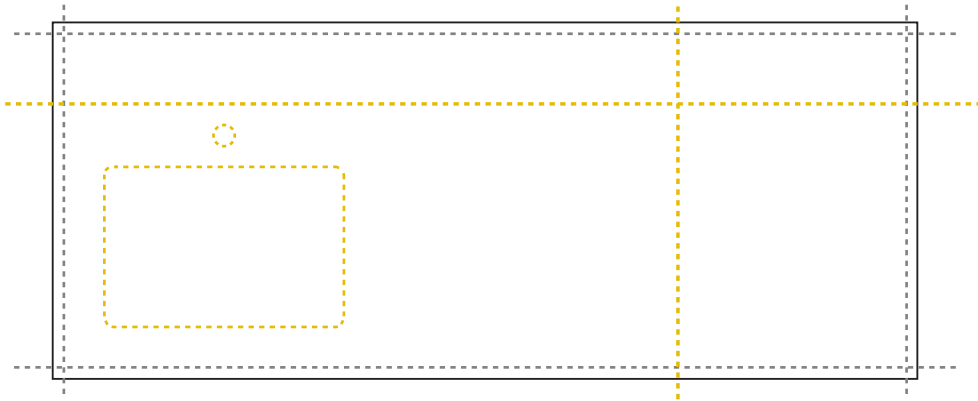

STEPS:

- 1 Perimeter cut, minimum 2 cm. (only for 12 mm and 20 mm)
- 2 Cutting.
- 3 Preparing the cutouts.
All inner corners require a minimum radius of 3 mm.

We recommend radiuses of more than 3 mm when the kitchen design allows as it will make the countertop firmer.

Remember that the perimeter cut of the slab to release stress may be used as a final cut for the part to be made.

Lower pressure is recommended for drilling holes.

To do the cutouts, beginning the cut at an internal point in the cutout and then getting closer to the cut perimeter is recommended:

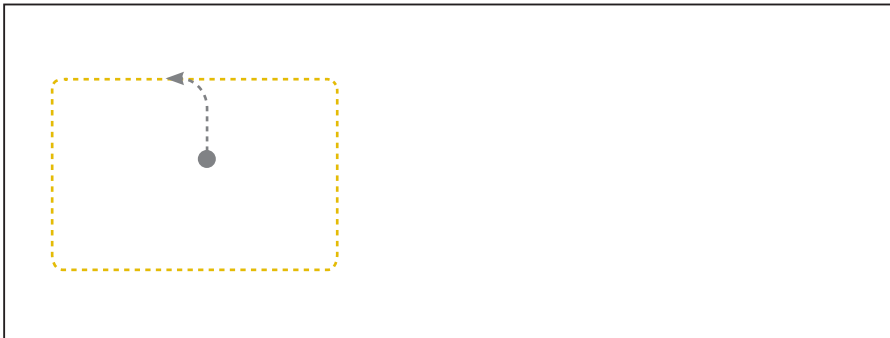

To do large cutouts or large parts, you must remember the following cutting sequence:

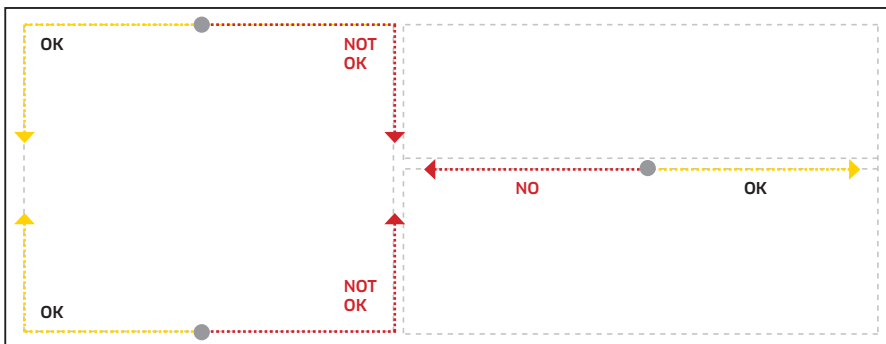

First cutting towards the edge of the slab from the hole or in parallel to the edge of the slab and following this direction to finish the part is recommended. Making the first cut towards the center of the slab is not recommended.

5.3 Digital control bit

Before beginning:

Check that the bench is straight and level and that the suction cups are free of any debris. Check that there is enough support for the slab.

Make sure there are suction cups below the entire slab, especially below the part to be cut.

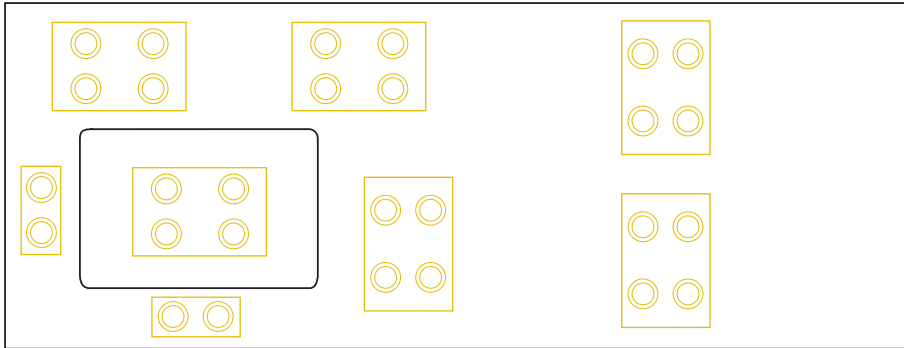



Use plenty of water to cool the tool during production in the inside and outside of the tool.

STEPS:

1. **Perimeter cut**, minimum 2 cm. (only for 12 mm and 20 mm)
2. **Drilling** with a crown bit.
3. Preparing the **cutouts**. All inner corners require a minimum bit of 3 mm.

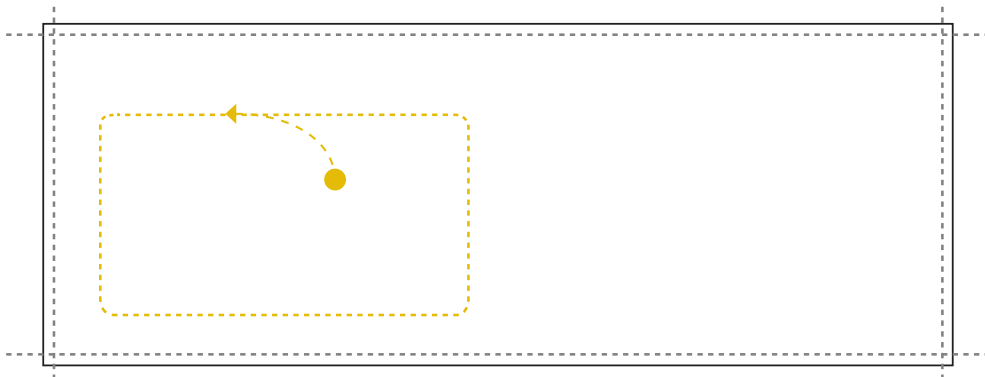
We recommend bits larger than 3 mm when the kitchen design allows, as it will make the countertop firmer





First drill a hole inside the cutout, using the crown bit. Afterwards, use the router bit to get closer to the cutting line.

As you get closer to the cutting line, curve a bit; do not use a perpendicular approach as this could create a notch.

At the end of the cut, reduce the speed to 50% as you complete the cutout.

Tips for digital control bits.

- **Crown bit:**
Drill the slab with the lowest downward speed possible, especially at the end of drilling. Before completing the drilling, raise the crown a bit to remove the pressure from the inside of the crown.

- **Router bit:**
Always begin from a hole previously made with a crown bit.

Never lower the router bit directly onto the surface.

The first two times, eliminate only 0.5 mm; then 2 mm per pass.

Removing more than 6 mm on a 12 mm slab or 10 mm on a 20 mm slab is not recommended.

- **Cutting bit:**
Do not use the oscillation option during cutting; this could cause splintering.

The clearest models (Arctic White, Estuario, Calacatta) are harder for tools given the specific raw materials used;

TheSize recommends lowering cutting speeds for these models to prevent tool overheating.

06. DESIGN AND PRODUCTION OF A NEOLITH
COUNTERTOP

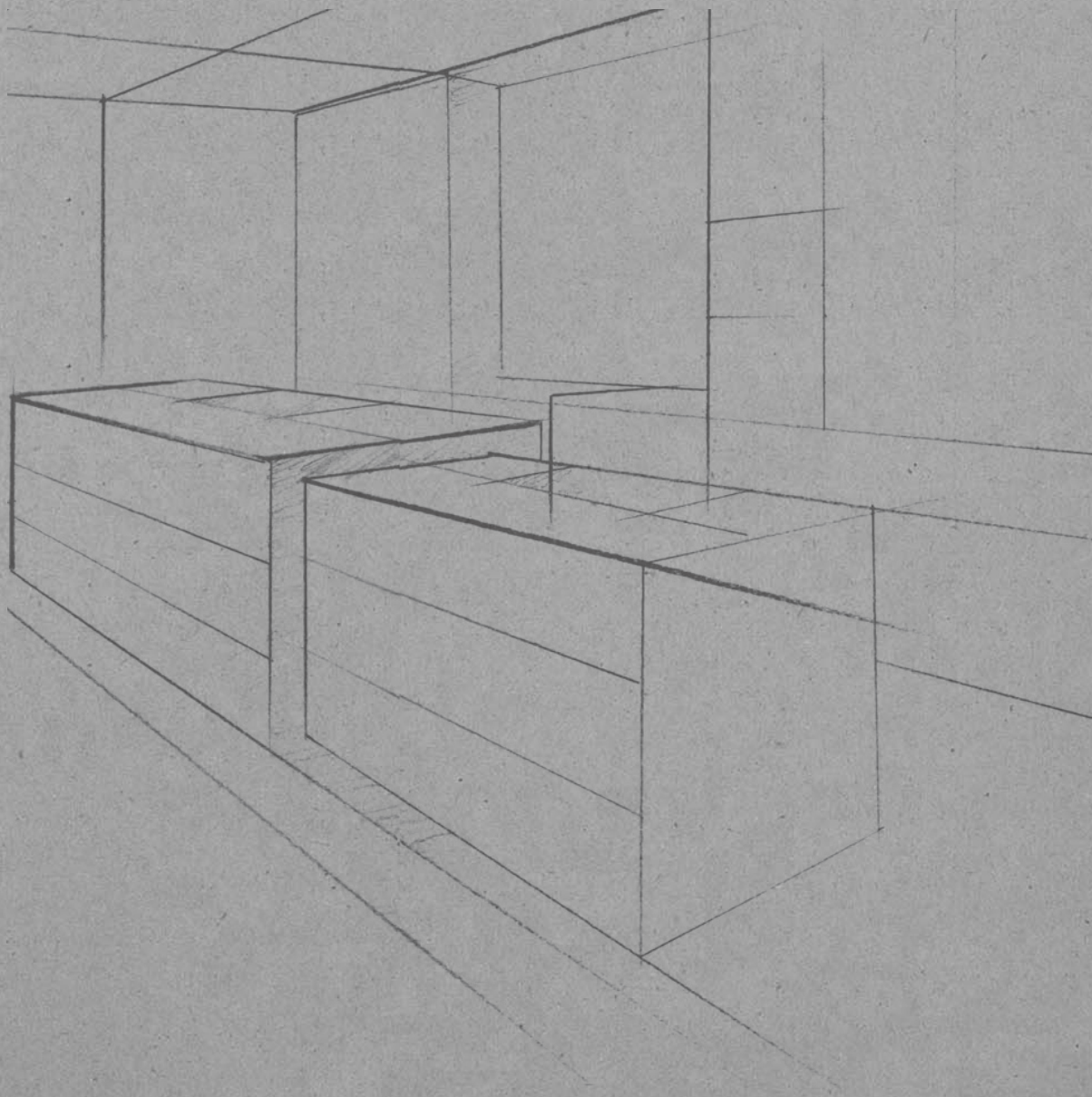

TheSize Surfaces recommends the following end uses for the various Neolith thicknesses:

- Paneling: 3mm, 3+, 6 mm and 6+
- Paving: 6 mm, 6+, 12 mm and 20 mm
- Countertops: 3+3, 6+3, 6+6, 12 and 20 mm.

6.1 Gaps

The minimum distance between a cutout and the edge of the slab must be at least 5 cm.

TheSize recommends distances greater than 5 cm when the kitchen design allows as it makes the countertop firmer.

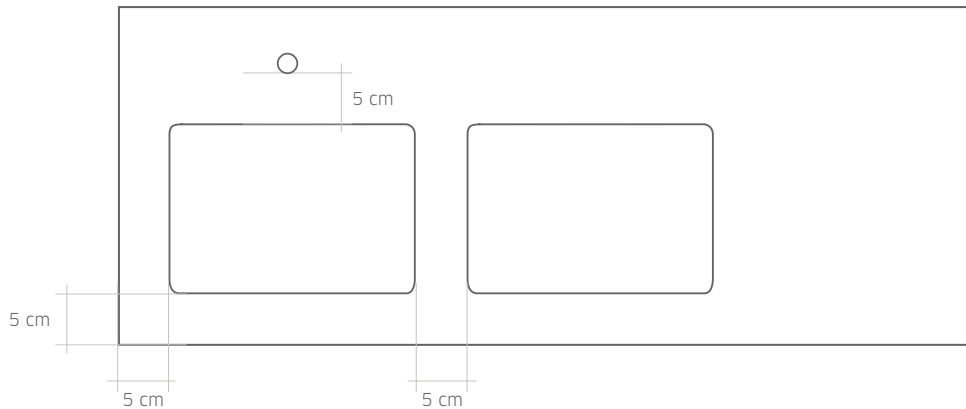

IMPORTANT



All cutout corners must have a minimum radius of 3 mm. Never leave 90° angles.

We recommend radiuses of more than 3 mm when the kitchen design allows as it will make the countertop firmer.



✓ CORRECT



✗ INCORRECT



✗ INCORRECT



✗ INCORRECT

The correct way to create a cutout, except with waterjet and digital control bits, is to first drill the corners and then the rest of the cuts.

Guidelines for cutouts:

- Two straight cuts must never be joined.
- No squared inner corners.
- All inner corners must have a minimum radius of 3 mm.

The bottom and top edges of the cutouts for vitroceramic cooktops, sockets or switches are often a bit sharp or irregular; therefore, beveling them with special diamond or paper discs or even abrasive sanders is recommended.

Polishing the edges of the cutout is recommended to eliminate any micro-fissures created when cutting. The more intense this treatment is, the less risk there will be in the future



✓ CORRECT



✗ INCORRECT

If the countertop design so allows, avoid Neolith countertops with unbalanced weights:



Irregular cuts are also not recommended such as for a “farmhouse sink”; in these cases, add joints to the countertop design:

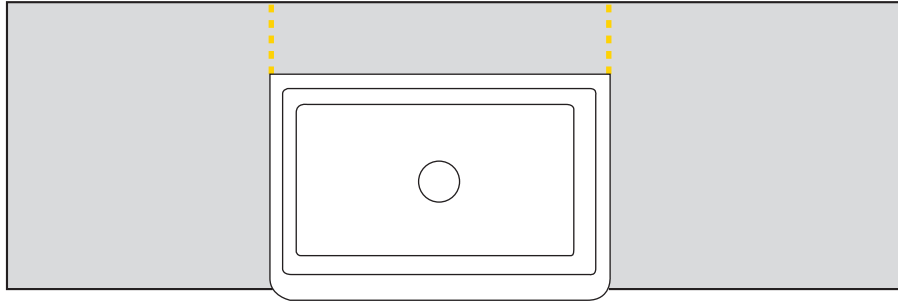

✓ CORRECT

Other types of designs to be avoided:

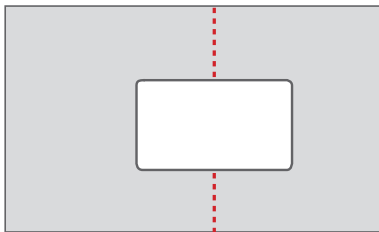

✗ INCORRECT

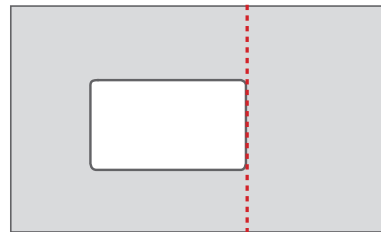

✗ INCORRECT

Sockets and switches:

Gaps made to insert accessories (sockets, switches, etc.) should be done using circular drills; they may overlap.

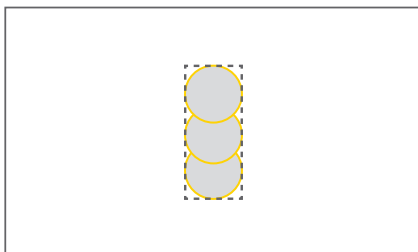

✓ CORRECT

6.2 Countertop reinforcement

▶ Countertops with 45° edges:

Reinforcements for 45° edges must be made with Neolith strips or dense granite; be careful when using other materials for reinforcement. The difference in the thermal expansion can cause the countertop to curve or the 45° edges may open over time.

NEVER USE QUARTZ REINFORCEMENT.

For countertops with 45° edges, reinforcements must be installed for greater countertop firmness, especially with 3+3, 6+3 and 6+6 thicknesses. These reinforcements must be distributed around the perimeter in such way that they find direct support on the sides of the kitchen furniture.

Moreover, it is important to reinforce the perimeter of the cutouts for greater strength and firmness in the area:

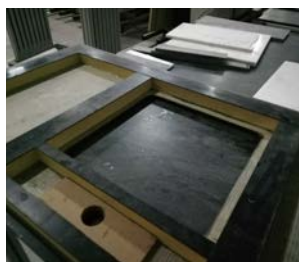
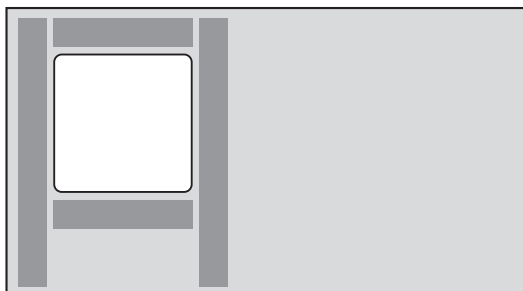

Reinforcements with expanded Polyurethane

▶ Countertops with a straight edge:

For straight edge countertops, where no inner structure can be hidden, a continuous surface like a wooden plank, Kerdi-Board or similar element should be placed over kitchen furniture.

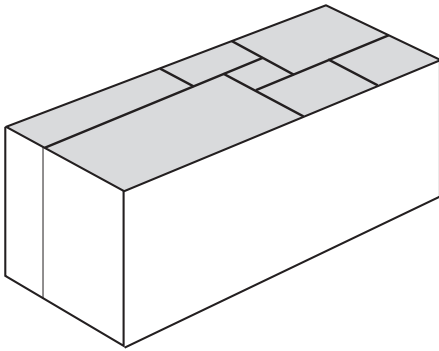

▶ 3+3, 6+3 and 6+6 Neolith countertops

Besides the aforementioned written recommendations, inserting a reinforcement piece (wood or similar) in the faucet gaps is recommended to reinforce this area. This reinforcement will distribute the forces generated during installation and daily use.



NEVER USE QUARTZ REINFORCEMENT!

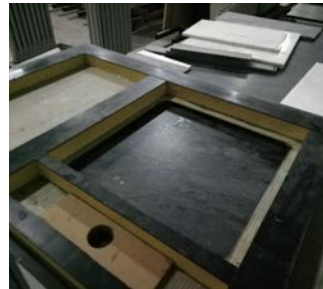
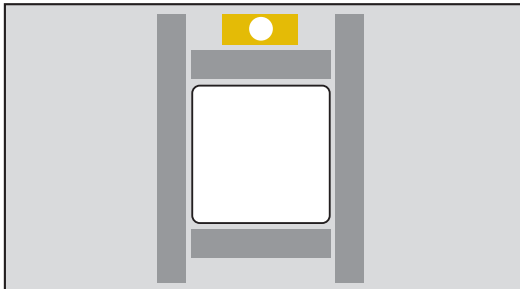

6.3 Draining racks

With a Neolith countertop, the only solution is creating sloped channels and combining them with an undermount sink.

The grooves can be made in the size and shape that best adapts to the kitchen design. For example:

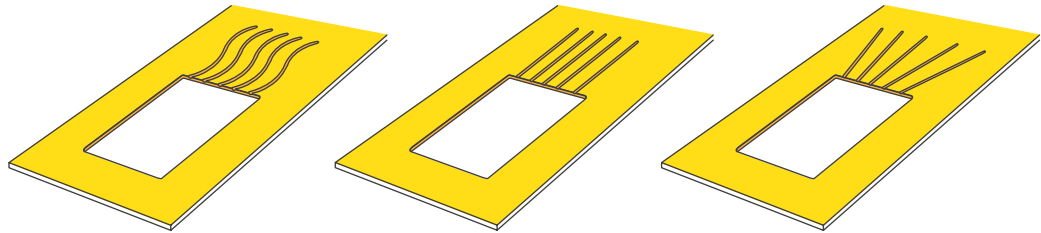

Wavy

Straight

Fanned

The following considerations must be observed when making the channels:

- This part of the countertop will require additional cross-reinforcement.
- The maximum depth of the channels is 3 mm for 12 mm thicknesses and 5 mm for 20 mm thicknesses.
- Sloped channels are not recommended for 3+3 and 5+3 mm countertops.
- The minimum distance between channels should be 1 cm.
- NANOTOP by LITHOFIN or a similar product should be used to seal the grooves.

Please remember that the base color of the slab will be visible upon creating the grooves and it may contrast with the surface design in some models. Depending on the model, the grooves may change color and be void of the design.

► Manufacturing

Recess

Use a router bit and always begin at the sink gap. Never lower the router bit directly onto the surface.

The first two times, eliminate only 0.5 mm; then a maximum of 2 mm per pass.

Finish

Sand the grooves by hand to remove any marks made by the router bit. Use fine sandpaper until all marks have been removed.

Round the upper edges of the grooves and seal using NANOTOP by LITHOFIN or a similar product.

6.4 Sinks

▶ Flush sinks

TheSize only recommends the installation of flush sinks in 12 mm and 20 mm.

Removing more than 6 mm on a 12 mm slab or 10 mm on a 20 mm slab is not recommended.



▶ Undermount sinks

To reduce the risk of splintering to a minimum, a round edge with a radius of at least 2 mm is recommended.



For large-size sinks, place a rod support structure under the sink so the weight is on the rods and not the countertop.

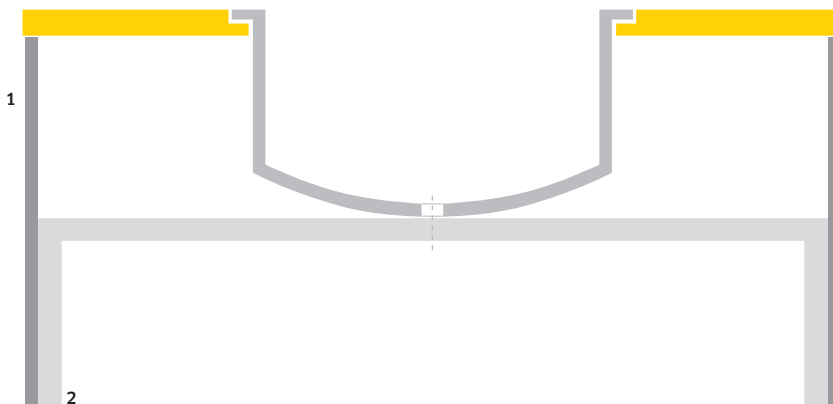

1. Furniture
2. Support rod

6.5 Edges and Joints

▶ Edges

TheSize recommends using the following edge for Neolith countertops. It is the perfect compromise between esthetics and functionality.

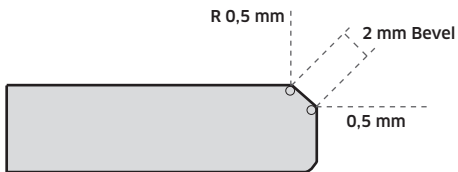

The edge is formed by a 2 mm bevel and by two rounded edges with a radius of 0.5 mm. The radius is barely visible but increases the edge impact resistance.

In high impact risk areas (sinks and dishwashers, for example), the edges could be as follows:



The greater the radius, the better it will bear any impacts. Remember that the greater the bevel, the more base color in the slab.

The edges can be wet or dry polished using standard granite or marble discs.

Recommended edges for Neolith:

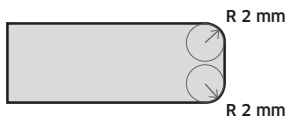

Round edge, R 2 mm

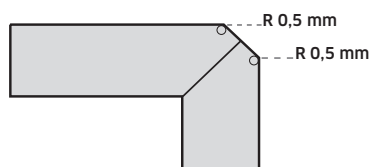

45° edge with a bevel, 2 mm

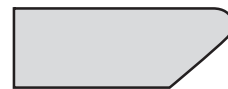

Inverted fluted peak



IMPORTANT

Polished edges must be treated with water repellent to permanently seal the edge.

TheSize recommends using NANOTOP by LITHOFIN or a similar product.

45° edge with a bevel 12 or 20 mm



Round polished edge



Inverted fluted peak



► Types of Edges

Straight iglete edge

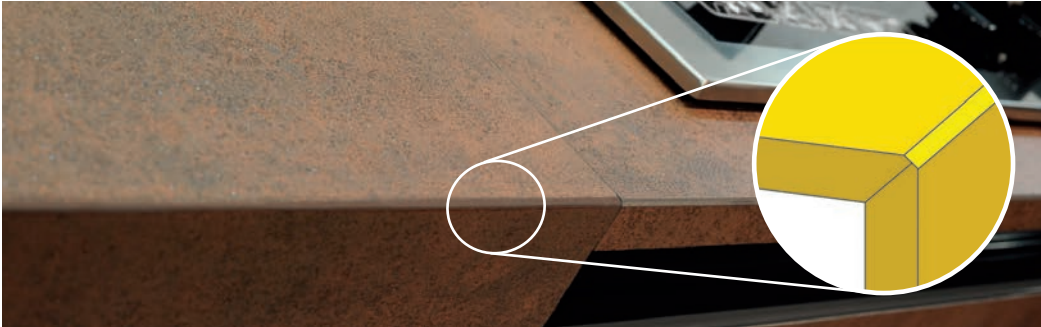

Pilaster edge



A testa edge





▶ **Joints**

Given the texture of Neolith slabs, a micro-bevel for all joints is recommended. Even if the straight edges are perfect, they may seem “splintered” due to the texture of Neolith slabs.

Each joint requires additional support (any technique will work).

The oven finish may not be “touched-up”; once the Neolith surface is polished or ground, there is no way back.

Producing samples so your customer can approve the edges and joints is highly recommended. (joint with a micro-bevel, 45° edge with a 2 mm bevel or a round 2 mm edge).

6.6 Glass-ceramic / induction stovetops

The minimum distance between the countertop and a stovetop must be 2 mm.

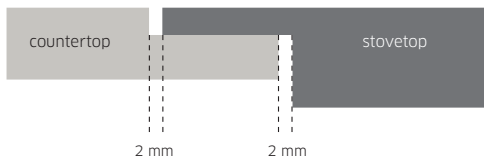

Use the right heat-resistant silicone or the joints supplied by the stovetop manufacturer.

Removing more than 6 mm on a 12 mm slab or 10 mm on a 20 mm slab is not recommended.

6.7 Countertop Installation

► Furniture:

Furniture must be in perfect conditions and level before installing the countertop. Cabinets must be secured to each other and then secured to the wall.

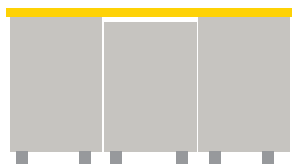

✗ INCORRECT

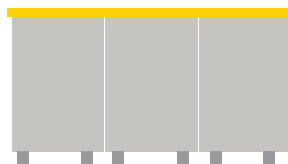

✓ CORRECT

► Expansion joints:

Given the irregularities in the wall and possible structural movements in the building, leaving a 3 mm perimeter expansion joint on the countertop is recommended. The point where the crown and countertop meet shall be sealed with a line of silicone:

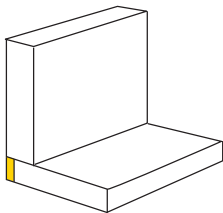

Flexible adhesive should be used such as 100% transparent adhesive to fill these joints and secure the countertops to the furniture and the floor or to secure the Neolith crowns to the wall. This will enable adequate thermal expansion.

Using flexible adhesives such as epoxy or liquid nails to secure the countertop is not recommended.

6.8 Overhang

Sizing the parts that will overhang must be taken into consideration during countertop designing, pursuant to the parameters indicated in the following table:

1. Full side overhang

A) Without cut-out

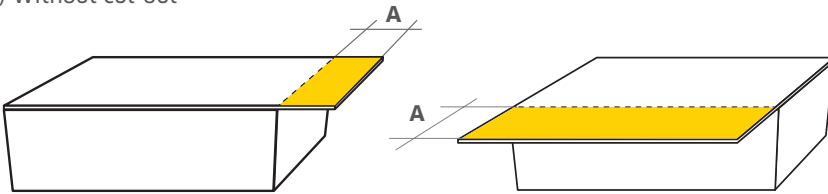

B) With cut-out

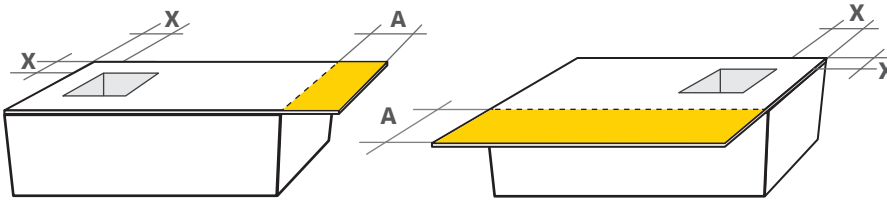

2. Partial overhang

A) Without cut-out

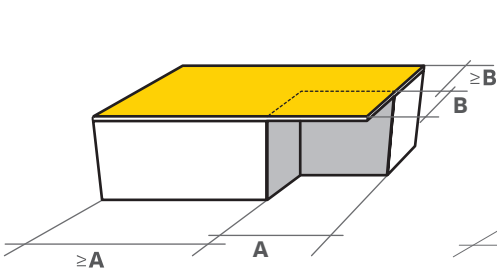

B) With cut-out

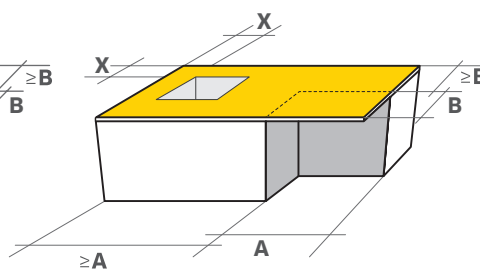

Thicknesses	
12 mm	20 mm
A ≤ 350 mm	A ≤ 500 mm
X ≥ 100 mm	X ≥ 100 mm
A ≤ 500 mm B ≤ 200 mm	A ≤ 1000 mm B ≤ 400 mm
X ≥ 100 mm	X ≥ 100 mm

Occasional maximum static load = 100kg
It is recommendable to reinforce the X sections with additional reinforcements of expanded polyurethane.

More examples of countertops with overhangs

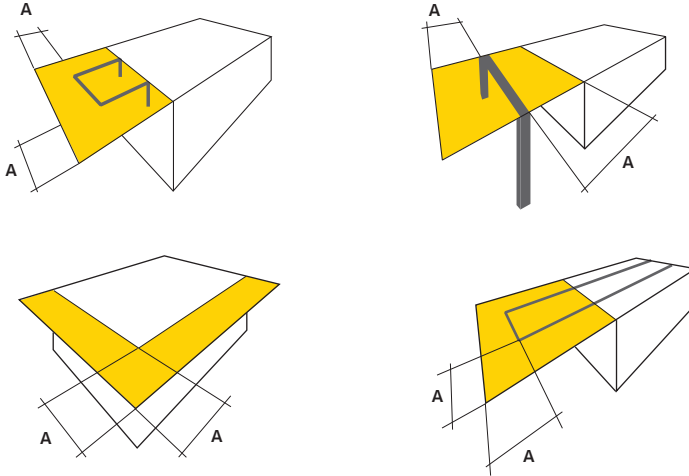

6.9 Outdoor countertops

Installing the countertop over a brick/stone or similar base or structure using C2 cement glue is recommended.

If there is no such structure available, covering the top of the existing structure with reinforced cement panels is recommended.

When installing outside, avoid the use of wood or agglomerate planks due to their tendency to expand and contract as the weather changes.

Using flexible adhesives such as epoxy, liquid nails or construction adhesives to secure a Neolith countertop is not recommended.



To glue the 45° angles, use an adhesive that is suitable for outdoor use and resistant to UV rays such as Integra Ultra.

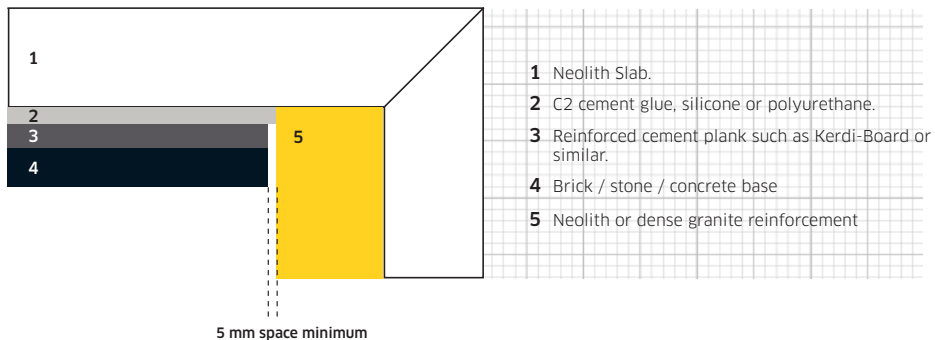

6.10 Observations

▶ L-shaped countertops

Dividing L-shaped countertops into several parts is recommended to avoid 90° corners in one part.



L-shaped countertops made of a single piece without a 45° angle must have a minimum radius of 2”.

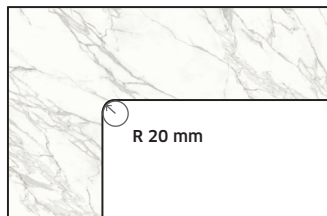

Make sure the furniture is in perfect conditions and level before installing this type of countertop.

07. EXTREME HEAT

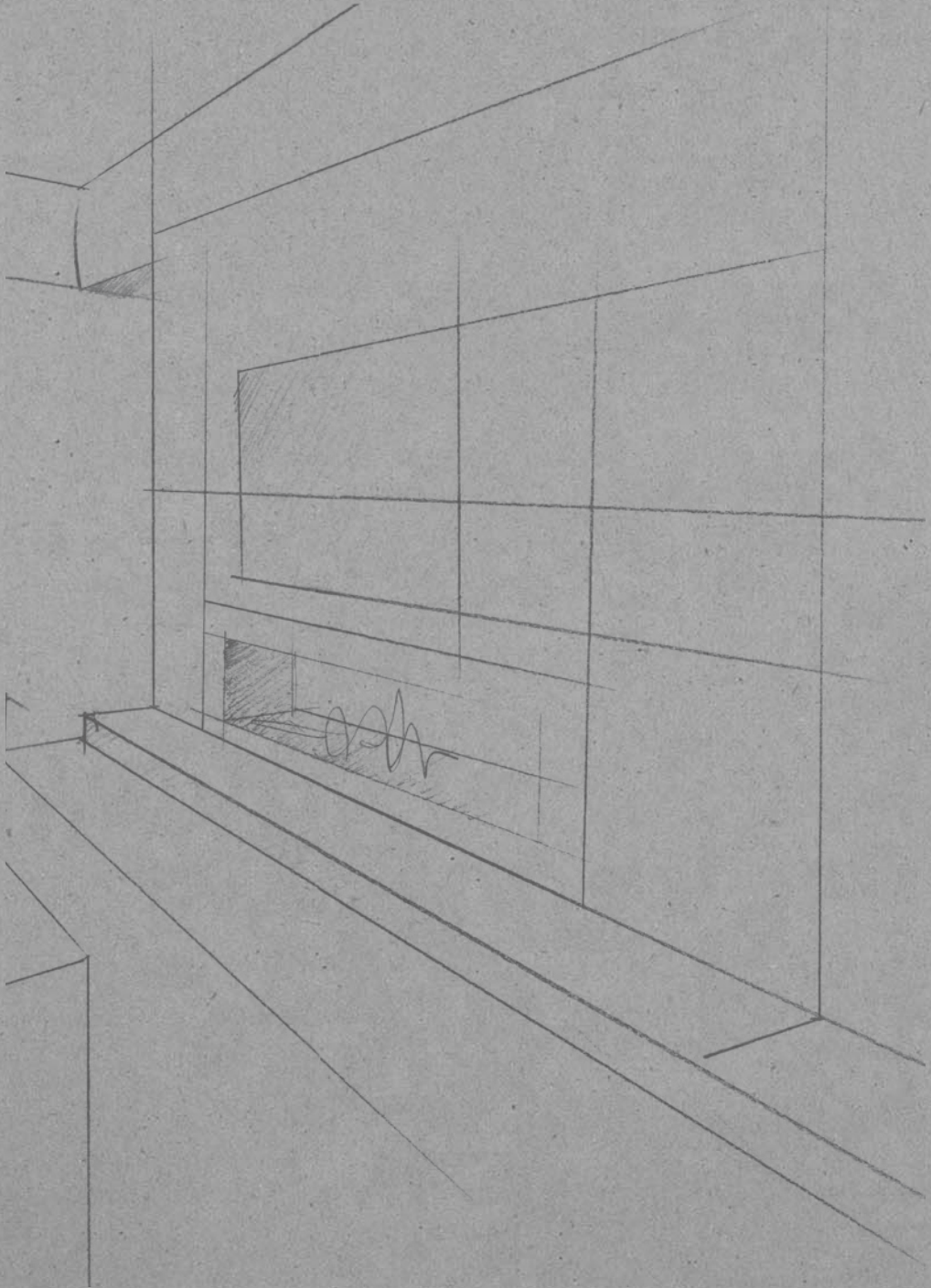

07. EXTREME HEAT

Neolith parameters that are essentially relevant for this use:

- ▶ **Maximum temperature: 300° C**
- ▶ **Linear thermal expansion: between 5.3° and 6.7°. 10-6 x°C-1**

If grills and/or barbecue grills are to be placed in a Neolith countertop, keep the following in mind:

- Always remember that all material expands when subject to temperature changes (i.e. the metal structure of a barbecue grill) to prevent stress due to a lack of space for such expansion.
- Metal materials expand much more than Neolith; therefore, prevent direct contact by leaving enough space (which will depend on the dimensions of the barbecue grill, maximum temperature it may reach, etc.).
- Polishing the edges of the cutout is recommended to eliminate any micro-fissures created when cutting. The more intense this treatment is, the less risk there will be in the future.
- Inner corners must have minimum radiuses of 10 mm. We recommend diameters of more than 10 mm or producing the countertop in several parts, when the design so allows:

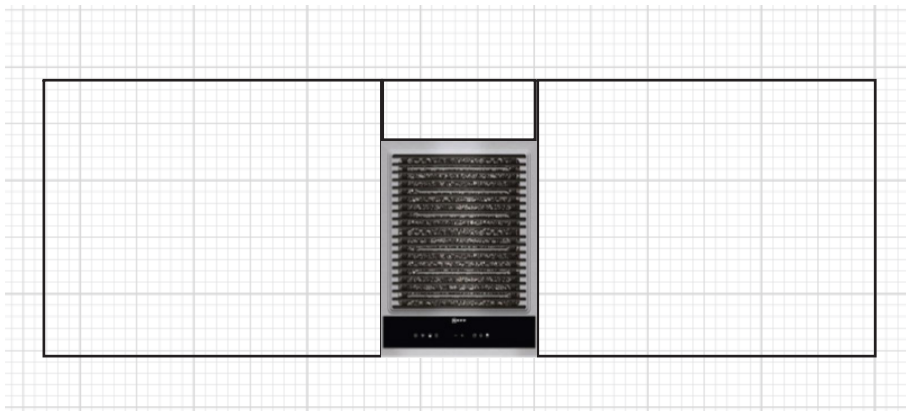

View of the top of the grill/barbecue grill built into a Neolith countertop

- Leaving a minimum space of 5 mm between the grill/barbecue grill and filling with thermal insulation such as fiberglass thermal insulation tape is recommended.



Neolith is not recommended for inner paneling for a fireplace.

Possible uses for Neolith with built-in barbecue grills:

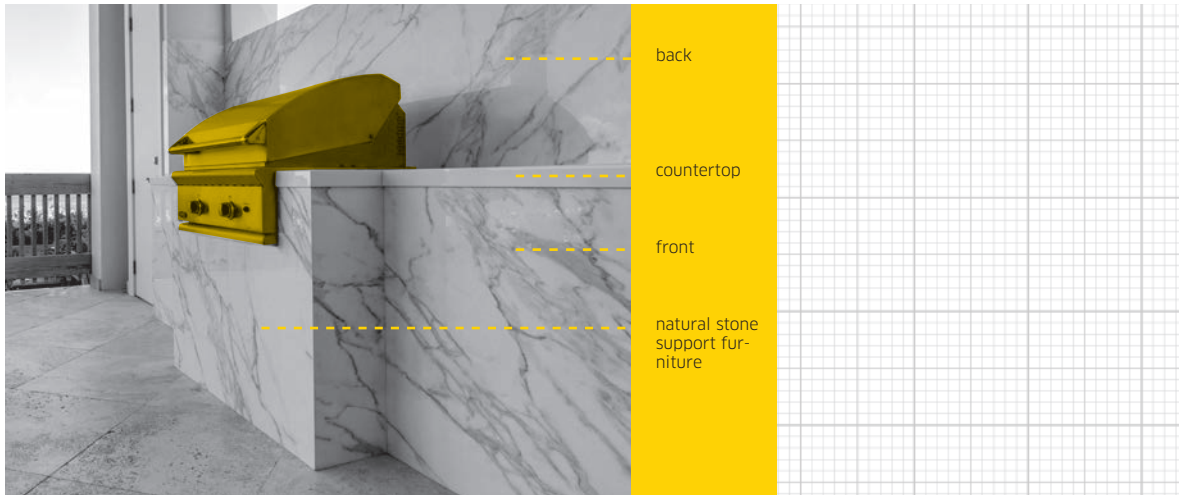

Possible uses for Neolith with fireplaces:

Front outer paneling: separated from the heat by an inner refractory wall (fire resistant).

Side outer paneling: separated from the heat by an inner refractory wall.

Countertop furniture

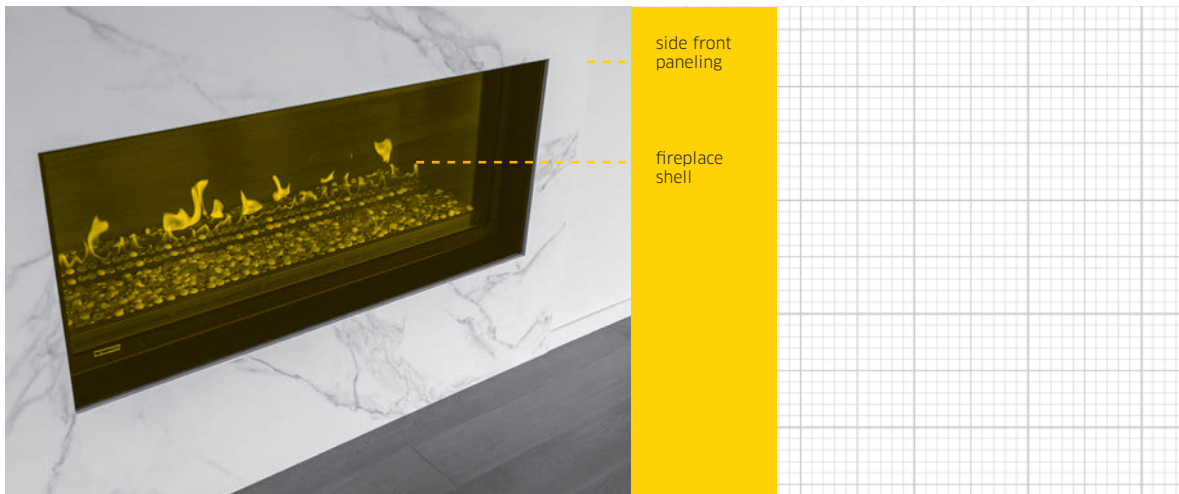

Neolith is not recommended for inner paneling for a fireplace.

Ethanol fireplace design

Front outer paneling: separated from the heat by an inner refractory wall.

Side outer paneling: separated from the heat by an inner refractory wall.



08. GLUE

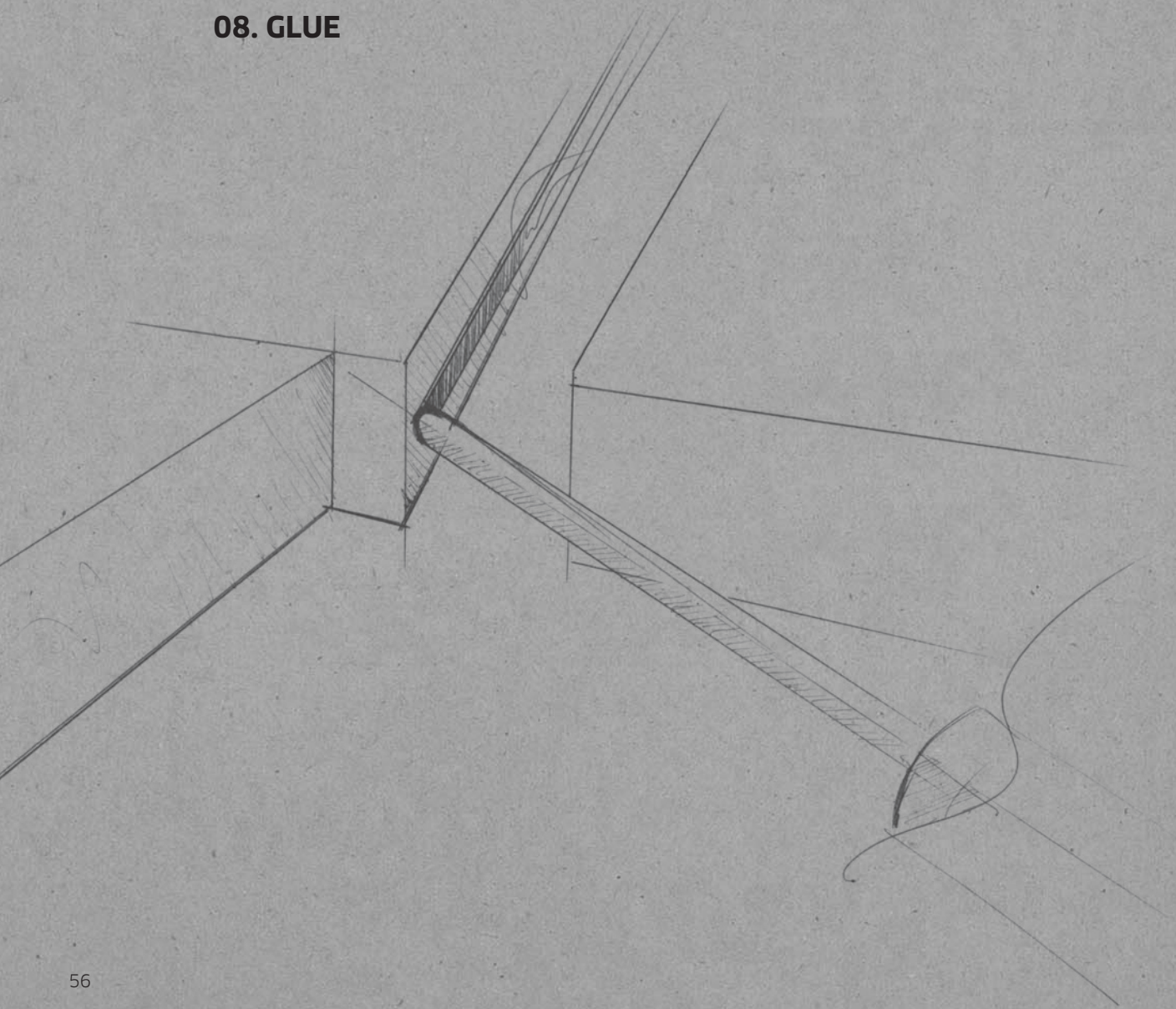

08. GLUE

Look at the side of the Neolith slab when preparing the glue color as the color of the surface is not exactly the same as the color of the slab base; this is important as polishing the edges will expose the slab base color.

Recommended glue: Integra or similar.

INTEGRA COLOR CATALOG:

Sheet name	Integra Match
Arctic White	Perfect - 720-314
Arena	Marfil - 720-310
Aspen Grey	Quarry - 720-423
Avorio	Marfil - 720-310
Barro	Meteor Grey - 720-311
Basalt Beige	Barley - 720-307
Basalt Black	Nacreto - 720-312
Basalt Grey	Meteor Grey - 720-311
Belgian Blue	Nacreto - 720-312
Beton	Light Grey - 720-310
Calacatta	Perfect - 720-314
Cement	Cement - 720-313
Concrete Taupe	Diana Pearl - 720-424
Estatuario	Perfect - 720-314
Iron Copper	Nacreto 720-312
Iron Corten	Nacreto 720-312
Iron Grey	Nacreto 720-312
Iron Moss	Nacreto - 720-312
Limestone Lava	Cement - 720-313
Marfil	Marfil - 720-310
Nero	Nacreto - 720-312
Nero Assoluto	Nacreto - 720-312
Nero Marquina	River Rock - 720-425
Nero Zimbabwe	Iron Grey - 720-426
Nieve	Perfect - 720-314
Onyx	Perfect - 720-314
Phedra	Light Grey - 720-309
Pietra Di Luna	Silk Grey - 720-316
Pietra Di Osso	Barley - 720-307

Sheet name	Integra Match
Pietra Di Piombo	Medium - 720-315
Pulpis	Clay Brown - 720-308
Strata Argentum	White Linen - 720-427
Textil Black	Cement - 720-313
Timber Ash	Cement - 720-313
Timber Ice	Perfect - 720-314
Timber Night	Meteor Grey - 720-311
Timber Oak	Cement - 720-313
Travertino Classico	Marfil - 720-310
Travertino Navona	Marfil - 720-310
Zaha Stone	Dove - 720-422

AKEMI GLUE CATALOG:

Akemi Colour Bond P+ 6 min
Akemi Colour Bond P+ 12 min
Akemi Platinum P+
Akemi Spectrum Paste

09. TILING AND PAVING

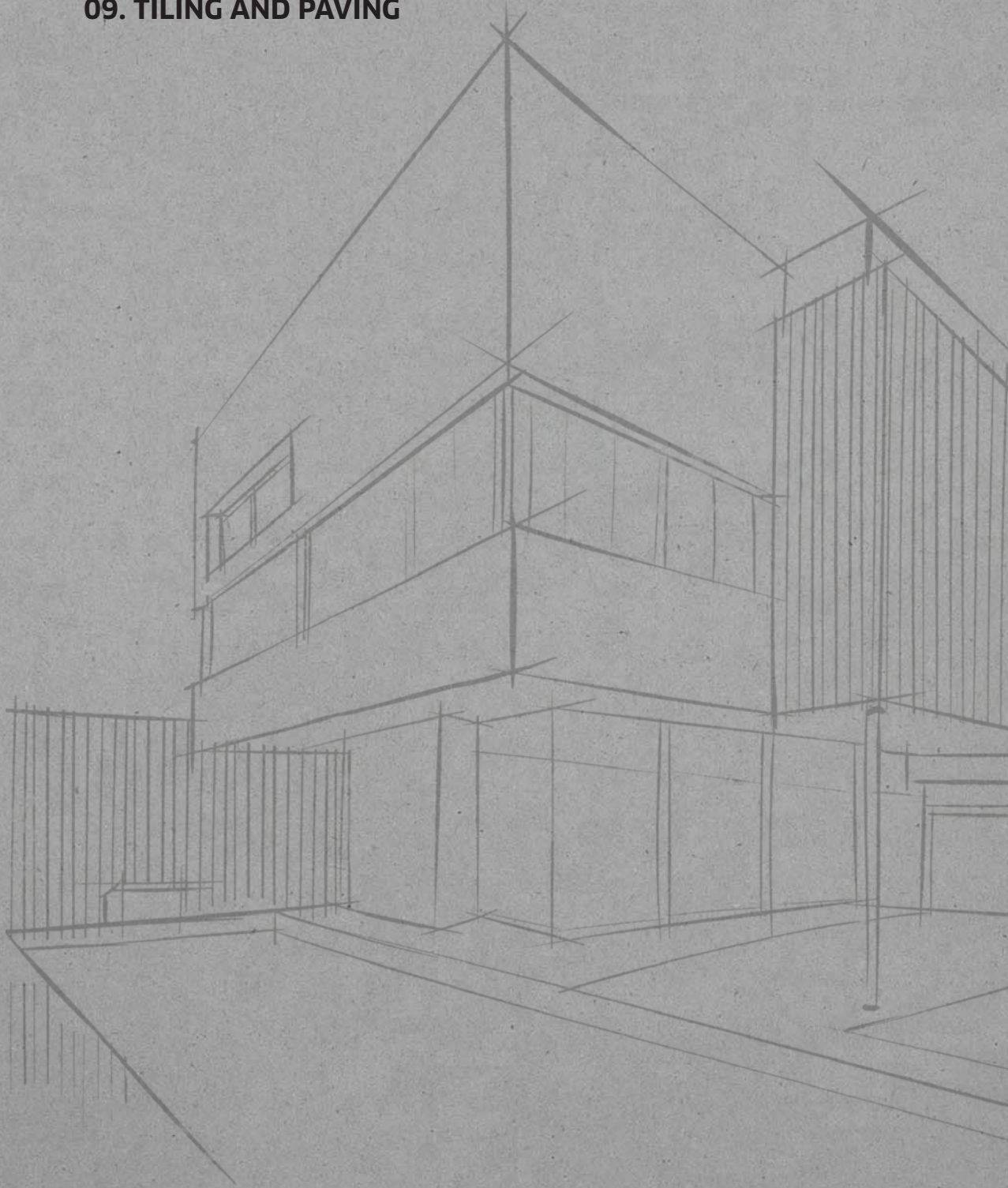

09. TILING AND PAVING

9.1 Indoor installation.

Leave a 2-3 mm space between tiles.
Create movement joints every 25 m² or as dictated by applicable national law.
The adhesive must be applied with a notched trowel using the double-glue technique; in other words, the adhesive must be applied to the back of the tile and the sublayer.

Neolith must be installed with **class C2** adhesive pursuant to standard EN 12004 and class "**highly flexible S2**".

9.2 Outdoor installation.

Create flexible movement joints of around 1 cm wide in the corners. Create movement joints every 9-12 m² or as dictated by applicable national law.
The building structural joints must be absolutely respected.

The tiles must be installed with a large joint between them. The width of the joint must be determined pursuant to the local climate conditions, the size of the tiles and flexibility of the sublayer.

In warm climates and during poor weather (strong winds, for example), using **class E** adhesives (with open time) is recommended pursuant to standard EN 12004.

In cold climates and during the winter, it is best to use class F adhesives (quick fixing) as per EN 12004.

9.3 Tiling over other Tiles.

Check that the old tiling is well-fixed. Otherwise, remove any loose tiles and fill the gaps with mortar that is compatible with the support.

Wash the old tiling with water and soap to eliminate any grease or dust, rinse well and let dry.

Apply bonding resin before tiling above the old tiles, following the recommendations for installation indoors or outdoors.

9.4 Manual Cutting

Manual ceramic cutter:

Neolith can be cut without any problems using traditional machines. Thicknesses of 3 and 6 mm can be cut using manual cutters. Cutting with a grinder is recommended for 12 mm. If the part has reinforcement mesh, the mesh must be cut with a cutter after splitting.

Grinder:

Tiles may be cut with no problems using a diamond disc available from TheSize.

Irregular cut:

Use crown bits, available from TheSize, for round holes. Gaps made to insert accessories (sockets, switches, etc.) should be done using circular drills; they may overlap.

A radius of at least 3 mm must be left on any inner corner of a gap. Never leave a 90 degree angle.

9.5 Tile Rejointing

Recommended Products:

High-performance, anti-fluorescence, quick fix and dry, water-repellant, anti-mold, class CG2 as per EN 13888.

High-performance, polymer modified, water-resistant technology for filling joints of up to 6 mm wide, class CG2 as per EN 13888.

Deep clean the surface after re-jointing with the right soap, wash the surface and absorb any excess water using the right equipment and do any other necessary operations to complete the work as per the specifications.

For more information, read our **"Tiling and Paving Guide"**, available in the download area on our website: www.neolith.com.

10. REPAIRS

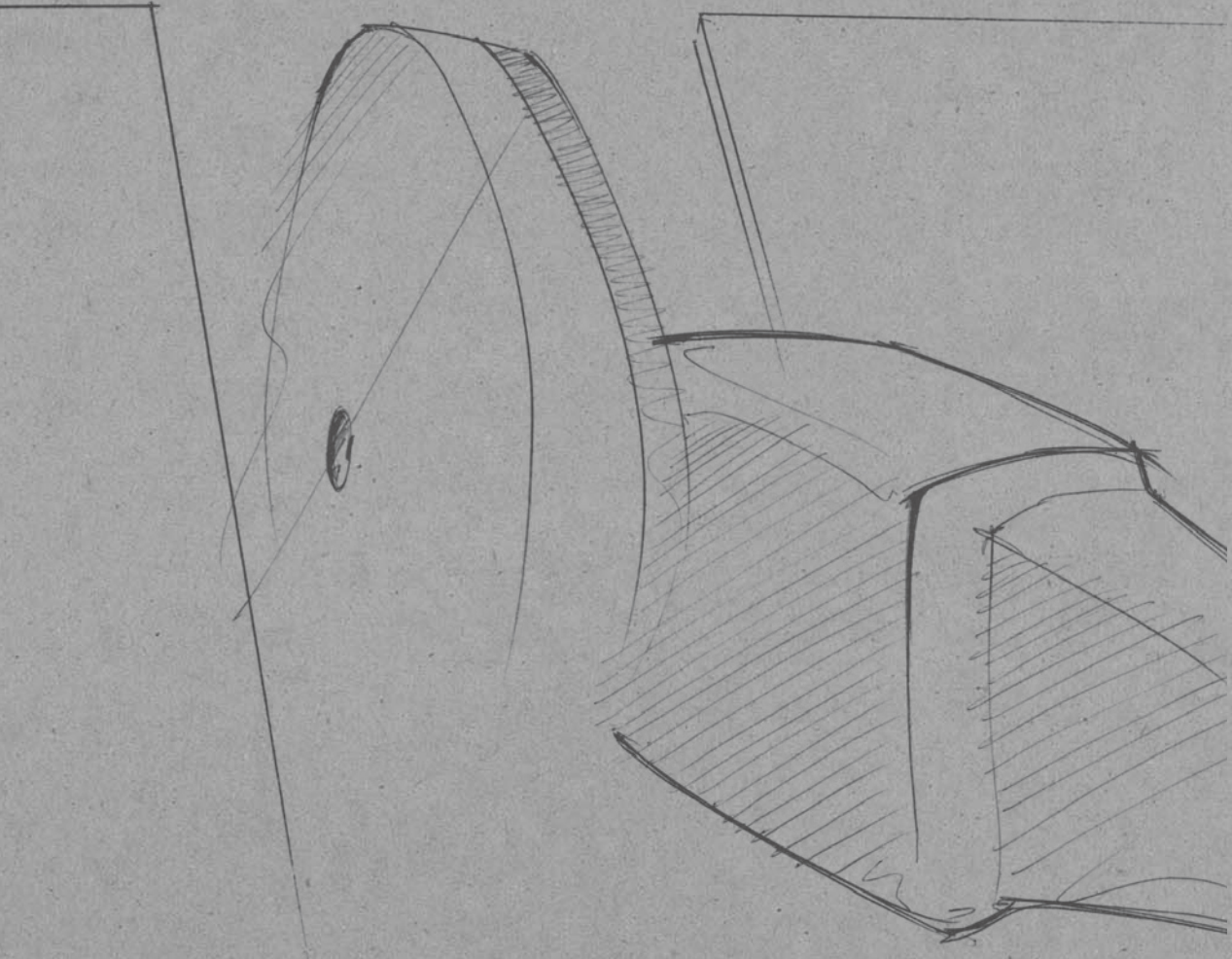

10. REPAIRS

10.1 Chip repair

Ceramic surfaces can be damaged for many reasons. Most of the time it is due to a defect caused by a plate that falls down or a heavy object.

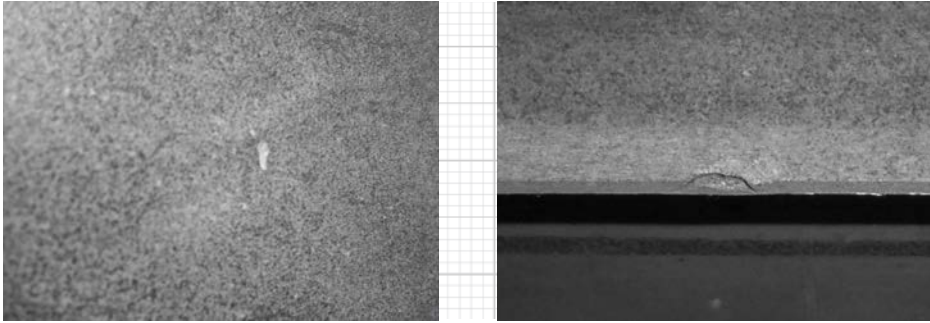

Keep in mind that no repair is perfect; it's very difficult to duplicate the tone and texture of a surface with resins.

Step 1:

Mix the bi-component epoxy resin, adding the color to color the epoxy so it matches the Neolith countertop.

Tip:

Repair all defects at the same time as the bi-component epoxy will cure quickly. And only mix enough to fill the defects with a little left over: epoxy resin cannot be stored once mixed.

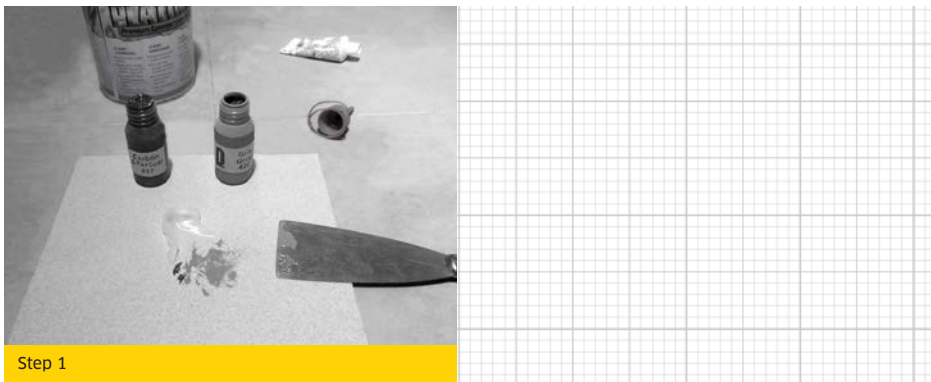

Step 2:

Use a Neolith fragment to imitate the surface finish and fill the defect with the mixed resin.

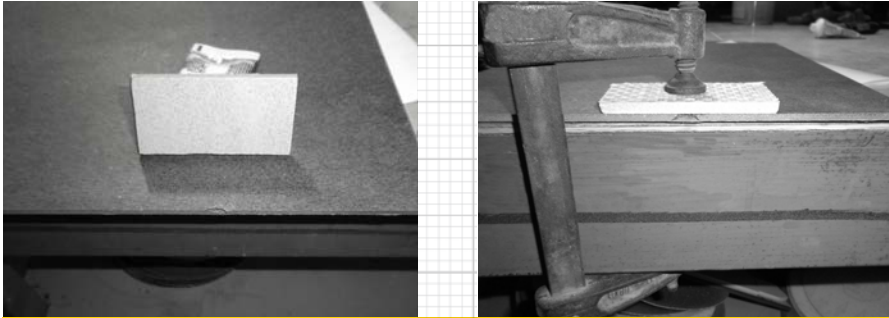

Step 2

Step 3:

Use an acetone-soaked cloth to add additional texture to the resin to imitate the adjacent surface even better.

Make sure the level of resin does not exceed the surface.

Clean the excess resin from the surface before it hardens with an acetone-soaked cloth.

Step 4:

Once the resin hardens, remove the excess resin in the edge mechanically. For surface repairs, it's best to work manually to prevent damage to the surface.

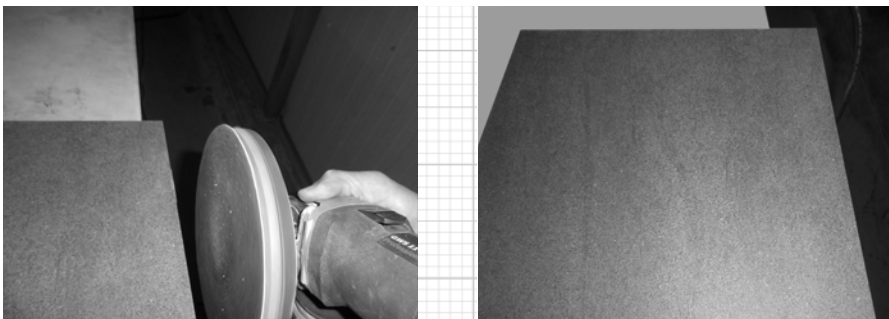

Step 4

10.2 Repairing surface scratches in Neolith Polished.

Necessary materials:

- Cerium oxide powder (90% purity, optical quality)
- Rubber gloves
- Smooth cloth
- Water
- Electric drill / Grinder
- Polishing pad (lamb wool, felt or leather pads)
- Spray bottle
- Goggles

Determine the depth of the scratches before polishing the scratches on the surface. If you can feel the scratches with your fingernail, they're too deep to be polished with cerium oxide. You must first sand the entire surface.

Only then can you polish the surface with cerium oxide.

Instructions:

1. Mix a little cerium oxide with the water to form a fine paste (creamy consistency) - mixing in a small bowl is recommended so the paste can be applied easily to the polishing pad.
2. Deep clean the surface to eliminate all dirt and grease residue.
3. Apply the polishing paste to the pad.
4. Place the pad on the drill and work the area.
5. Move the pad up and down, left and right in the area.
6. Keep the surface damp to prevent overheating - if there's enough paste, just spray a little water on to keep the area damp.
7. Clean any residue and inspect the repair - keep working until you get a satisfactory result.
8. Clean the pad for later use.



11. PROTECTIVE EDGES & PROFILES

11. COUNTERTOP EDGES

EDGES & PROTECTION PROFILES

11.1 Work Areas subject to Harsh Conditions

Even though a **Neolith®** countertop is resistant to impacts, there are harsh work atmospheres in which the edges recommended in section 6.5 of our **countertop technical manual** are not enough to properly protect the countertop in these environments.

In these areas with a **high risk of impact**, behind a restaurant bar counter, for example, rounded edges should be considered for the countertop.

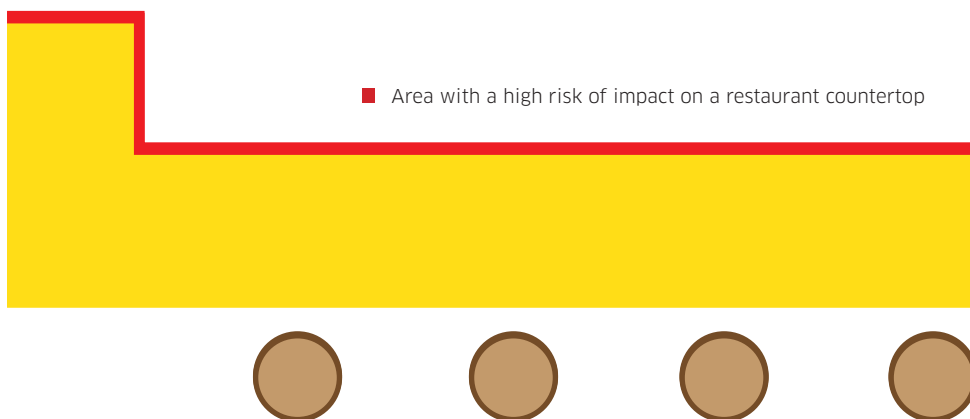

Due to the design of some models, this option may not be the most aesthetic measure.

To solve this problem, **TheSize** sought the assistance of **Schlüter®-Systems**, whose construction systems are the result of extensive experience in the sector and guarantee a good final finish.

Schlüter®-Systems produces several profiles that are suitable for protecting **Neolith®** countertop edges.

Below is a summary of some profiles that have led to the best results with the various **Neolith®** models and thicknesses.

The profiles can be secured to the countertop with industrial silicone like **SoudalT-Rex**. The joint between the profile and the **Neolith®** countertop was rejointed with **Akemi Composil** colored silicones.

- ▶ Profiles combined with a substrate like **Schlüter®-Kerdi-Board** or similar.
- ▶ Sometimes, substrates like **Schlüter®-Kerdi-Board** are used. **Schlüter®-Kerdi-Board** is an extruded rigid foam panel covered on both sides with special reinforcement material to guarantee the effectiveness of the adhesive. **Schlüter®-Systems** has developed various types of profiles to cover the visible edge of the substrate.

Schlüter®-Rondec-Step

Schlüter®-Rondec-Step is a profile which, in combination with a Neolith countertop, creates a symmetrical outer corner and covers the front edge of the countertop. The profile comes in two aluminum finishes and allows for different decorative designs and interesting contrasts.



■ 1. Neolith Beton 12 mm with **Schlüter®-Rondec-Step** and its outer angle

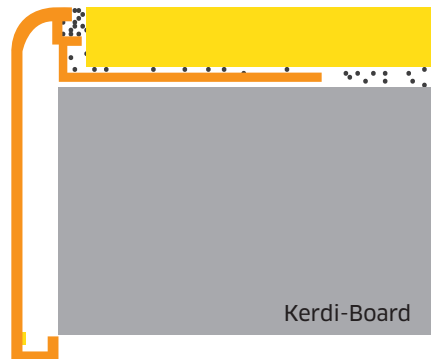

■ Cross-sectional image of a **Schlüter®-Rondec-Step** profile

Schlüter®-Rondec-Stepct

With **Schlüter®-Rondec-Stepct**, pieces with the same coating as the countertop as well as other materials can be inserted in the free space in the profile. Besides the decorative effect, the profile effectively protects the countertop edges from deterioration caused by mechanical aggressions. Special parts are available for **Schlüter®-Rondec-Stepct** to properly join the profiles to inner and outer corners.

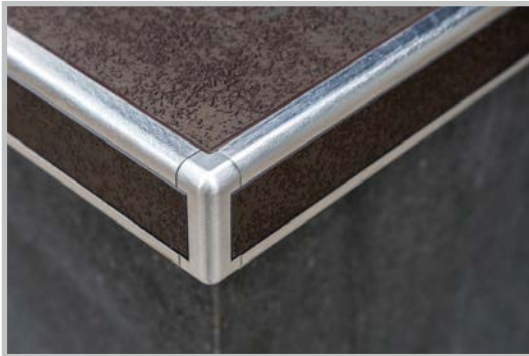

■ 2. Neolith Iron Copper 12 mm with **Schlüter®-Rondec-Stepct** and its outer angle

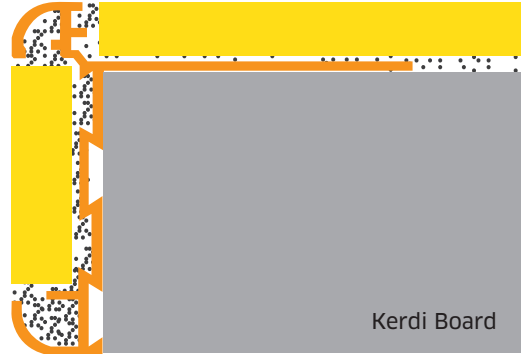

■ Cross-sectional image of a **Schlüter®-Rondec-Step** profile

The suitability of **Schlüter-Rondec-Stepct** should be checked in cases where chemical aggressions may occur. Aluminum is sensitive to alkaline substances.

Schlüter®-Schiene-Step

Schlüter®-Schiene-Step is the right profile for **Neolith®** countertops. The top of the profile features a vertical section that finishes and protects the countertop edges from possible impacts while the bottom covers the edge of the substrate.



■ 3. Neolith Zaha Stone 12 mm with **Schlüter®-Schiene-Step** and its outer angle

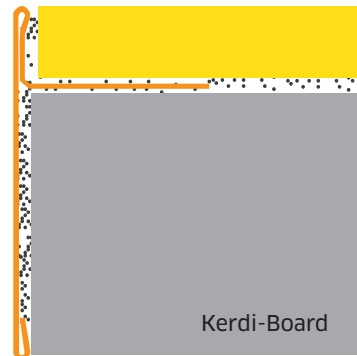

■ Cross-sectional image of a **Schlüter®-Schiene-Step** profile

- ▶ Profiles to protect edges

Schlüter®-Quadec

Schlüter®-Quadec is a high-quality finish stainless steel profile for countertops, which also provides good protection for edges. The surface of the profile creates a square outer corner that is symmetrical with **Neolith®** countertops.

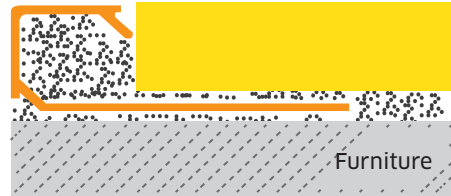

■ Cross-sectional image of a **Schlüter®-Quadec-TSG** profile

- 4. Neolith Cement 12 mm with **Schlüter®-Quadec-TSG** and its outer angle

Special parts as well as connections and covers for some finishes are available to easily and beautifully join **Schlüter®-Quadec** profiles to inner and outer corners

Schlüter®-Schiene

Schlüter®-Schiene is a special profile to protect and decorate the outer edges of **Neolith®** countertops.

The acting loads are deviated to the coating and support because of the thickness and special angle of the profile. Thus, the countertop edges are effectively protected from possible deterioration. A separator creates a defined joint between the profile and countertop.



■ Cross-sectional image of a **Schlüter®-Schiene-E** profile

- 5. Neolith Pierre Bleue 20 mm with **Schlüter®-Schiene-E**

Schlüter®-Jolly

Schlüter®-Jolly is a finishing profile for **Neolith®** countertop edges which also provides good edge protection. Since the profiles are available in different colors, the countertop and joint colors can be combined in addition to the possibility of creating interesting contrasts.



■ Cross-sectional image of a **Jolly- AC profile**

■ 6. Neolith Estuario 12 mm with **Jolly-AC**

Besides the decorative effect, the profiles also protect the countertop edges from deterioration due to mechanical aggressions.

The separator integrated in the profile creates an even joint between the profile and countertop.

▶ Other models



■ 7. Neolith Pietra di Piombo 12 mm with **Jolly-TSG**



■ 8. Neolith Pierre Bleue 20 mm with **Schiene-A**



■ 9. Neolith Iron Copper 12 mm with **Quadec-TSOB**



■ 10. Neolith Nero Zimbabwe 12 mm with **Jolly-AC**

► **Compositil - Akemi colored silicones**

Photo no.	Neolith® color	Schlüter®-Systems profile	AKEMI silicone (Compositil)
1	Beton Silk	Schlüter®-Rondec Step Brushed Aluminum	CC 1960
2	Iron Copper	Schlüter®-Rondec-Step-CT Brushed Aluminum	CC 2000
3	Zaha Stone Silk	Schlüter®-Schiene-Step-Eb Brushed Stainless Steel	CC 1840
4	Cement Satin	Schlüter®-Quadec-Tsg Lacquered with Gray Relief	CC 1805
5	Pierre Bleue	Schlüter®-Schiene-E Stainless Steel	CC 1880
6	Estatuario Polished	Schlüter®-Jolly-Ac Lacquered White	CC 1130
7	Pietra di Piombo Silk	Schlüter®-Jolly-Tsg Lacquered with Gray Relief	CC 1850
8	Pierre Bleue	Schlüter®-Schiene-A Stainless Steel	CC 1880
9	Iron Copper	Schlüter®-Quadec-Tsob Lacquered with Bronze Relief	CC 2000
10	Nero Zimbabwe	Schlüter®-Jolly-Ac Lacquered Black	CC 1000

► **Proyectos con perfiles**

Restaurant Miramar - Llançà, Girona, España

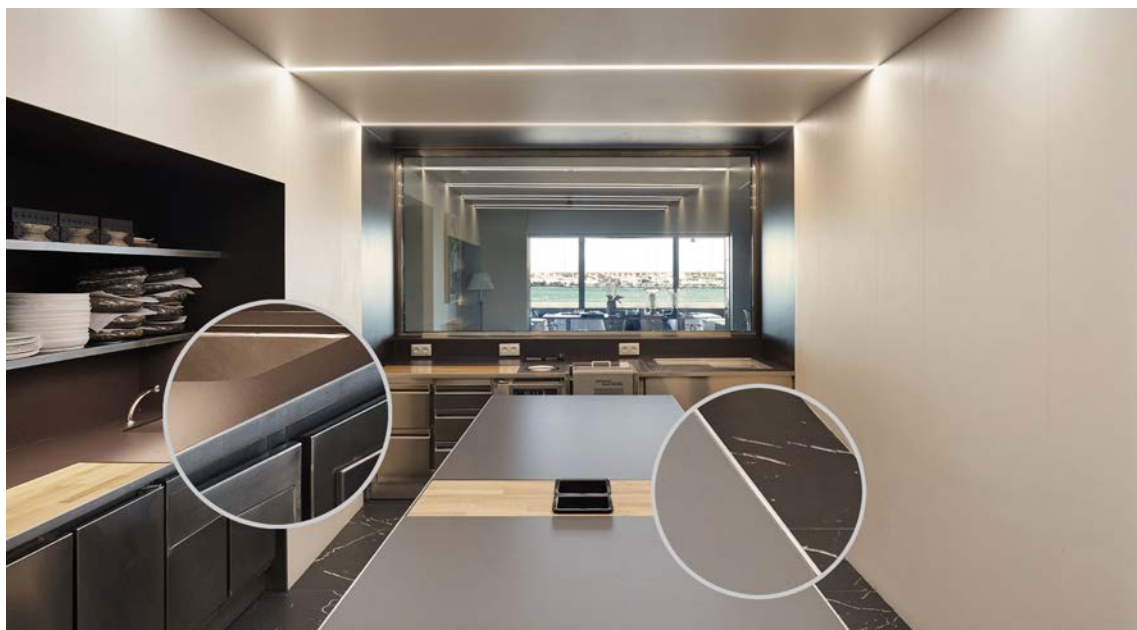

Restaurant Enigma - Barcelona, España



Restaurant Confusion - Porto Cervo, Italia



Restaurant Kutchiin & Campus Loft - Münster, Alemania



Gasma, Gastronomic University - Castellón, España

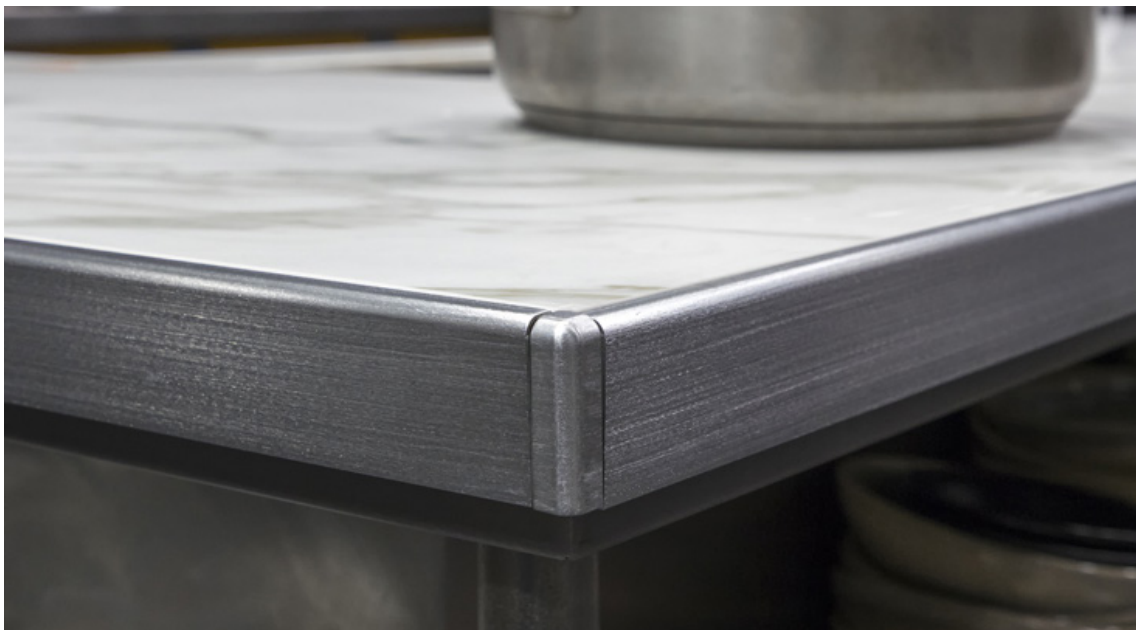

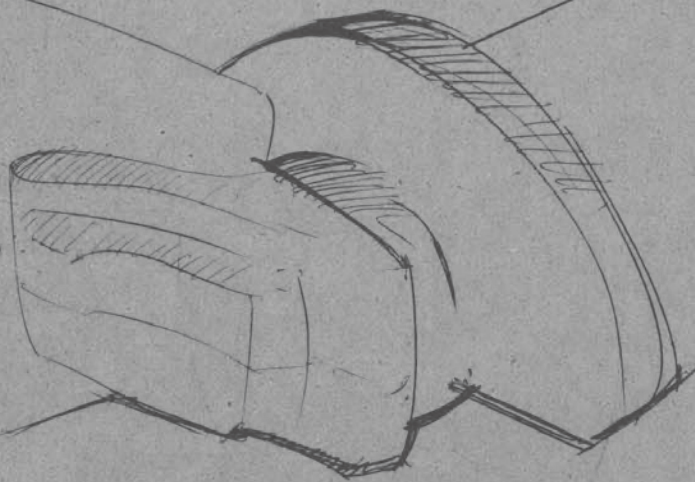
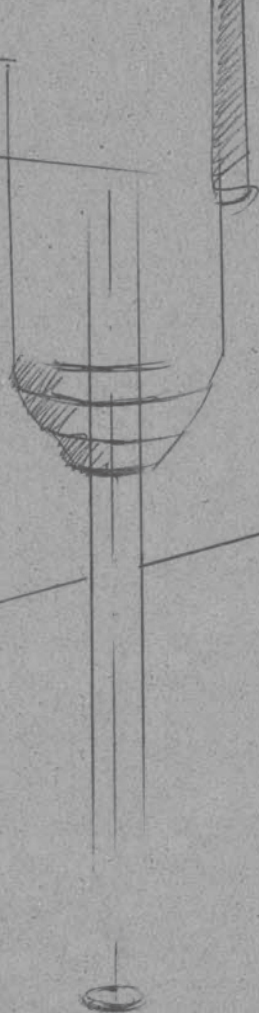

12. TOOLS

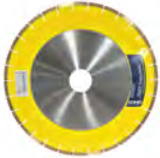

12. TOOLS

LARGE BLADES		
Diarex USC Blades for Ultra Compact Surfaces		
	DB300PUCS	Portable Saw only 300mm
	DB350PUCS	Portable Saw only 350mm
	DB350SUCS	Bridge Saw Speed 350mm
	DB400SUCS	Bridge Saw Speed 400mm
	DB400UCS	Bridge Saw Standard 400mm
	DB450SUCS	Bridge Saw Speed 450mm
	DB450UCS	Bridge Saw Standard 450mm

GRINDING CUP		
Diarex Pro-Series Grinding Cup 100mm Red		
	DCW4DP1A	Coarse M14 Thread #30/40
	DCW4DP2A	Medium M14 Thread #50/60
	DCW4DP3A	Fine M14 Thread #140/170
	DCW4DP4A	Ultra Fine M14 Thread #200/230

DIAMOND POLISHING DISCS		
Diarex Elite Polishing Pads 100mm		
	DE.4V.1	Polishing Pad Position 1 Red
	DE.4V.2	Polishing Pad Position 2 Yellow
	DE.4V.3	Polishing Pad Position 3 Blue
	DE.4V.4	Polishing Pad Position 4 Green
	DE.4V.5	Polishing Pad Position 5 Orange
	DE.4V.6	Polishing Pad Position 6 White

VACUUM BRAZED CORE DRILLS		
Diarex Ultra Vacuum Brazed Core Drills with M14 Thread		
	DCD006VDU	Core Drill 6mm
	DCD008VDU	Core Drill 8mm
	DCD010VDU	Core Drill 10mm
	DCD020VDU	Core Drill 20mm
	DCD025VDU	Core Drill 25mm
	DCD030VDU	Core Drill 30mm
	DCD032VDU	Core Drill 32mm
	DCD035VDU	Core Drill 35mm

ROUTER BIT

UCS Finger Bit for UCS Materials 22x35mm



MT74022	UCS Finger Bit 20x15mm
MT74028	UCS Finger Bit 22x25mm
MT74030	UCS Finger Bit 22x35mm

CORE DRILL (CNC)

ADI UCS CNC Core Drill



MT81135	Core Drill 35x75mm Magenta
---------	----------------------------

SMALL DIAMOND BLADES

Diarex Stinger Ultra Thin Blade - for Porcelain



DBT105US	105mm - 22.2mm bore
----------	---------------------

ROUTER BIT

Diarex Router Tip for Sintered Stone M12 Thread



DRT20UCS	Router Tip 20x14mm
----------	--------------------

POLISHING BLOCKS		
Diarex Diaflex Hand Pad 90x55mm - Metal Bond Flat Foam Backing		
	DFHP90M0060 DFHP90M0120 DFHP90M 0200	Hand Pad #60 Green Hand Pad #120 Black Hand Pad #200 Red

INTEGRA SURFACE BONDER XI	
Epoxy Modified Methacrylate Adhesive for Quartz, Natural Stone, Solid Surface, Sintered Stone and more... - For Indoor Use Only	
	IAXI250 For full Colour Charts get the Integra App.

INTEGRA ULTRA SURFACE BONDER	
A premium grade adhesive for bonding Engineered, Sintered and Natural Stone - For Indoor & Outdoor Use	
	IASB210 Bonder 215m For full Colour Charts get the Integra App.

MANUAL TILE CUTTER



Brevetti Montolit SpA

Australia

CDK Stone
4-6 Freighter Road
Moorabbin VIC 3189

P: 03 8552 6000

blog: www.cdkstone.com.au/montolit
email: info@cdkstone.com.au
web: www.cdkstone.com.au



Reference: 300-70 (SUPERSTICK)

Machinery: Manual tile cutter for Sintered Stone Slabs.

Features, Diameters, Observations:

- A complete system for cutting Sintered Stone Slabs from 0cm to 340cm.
- Non-slip system;
- Quick connection;
- Integrated lubrication;
- Quick cutting wheel change;
- International patent;
- 100% MADE IN ITALY



HANDLING SYSTEM FOR LARGE FORMAT TILES



Brevetti Montolit SpA

Australia

CDK Stone
Head Office
4-6 Freighter Road
Moorabbin VIC 3189

P: 03 8552 6000

blog: www.cdkstone.com.au/montolit
email: info@cdkstone.com.au
web: www.cdkstone.com.au



Reference: 300-70 (SUPERSTICK)

Machinery: Handling System for Sintered Stone Slabs.

Features, Diameters, Observations:

- It is designed to handle and position next-generation Sintered Stone Slabs 320cm x 160cm.
- The overall dimensions of the complete frame are also specifically designed so the tile slabs can be removed from the special packaging they come in.
- The telescopic handles provide for a more ergonomic grip.
- The 'Superstick' carrying frame allows the tile slabs to move in both horizontal and vertical directions and is equipped with telescopic legs for support on the ground so the tile remains in the frame without being damaged.
- The special suction cups are equipped with a vacuum safety gauge to indicate the force of adhesion to the tile slab.
- Made of galvanized steel to resist wear and corrosion.
- Max. load 80Kg

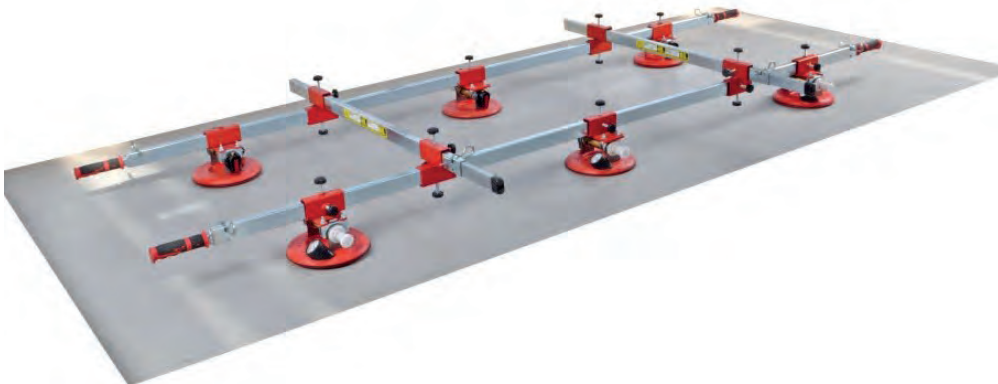

BOGIE FOR LARGE TILES



Brevetti Montolit SpA

Australia

CDK Stone
Head Office
4-6 Freighter Road
Moorabbin VIC 3189

P: 03 8552 6000

blog: www.cdkstone.com.au/montolit
email: info@cdkstone.com.au
web: www.cdkstone.com.au

Reference: 300-85 (GOAL)

Machinery: Bogie for Sintered Stone Slabs.

Features, Diameters, Observations:

- The ideal solution for moving Sintered Stone Slabs in warehouses or at installation sites.
- Easily folds to use less space during transport and storage.
- The 4 soft rubber castors on each corner offer superb movement and direction control as well as extreme stability.
- Two of the wheels have brakes which can be locked to keep the carriage in the desired position.
- Slabs up to a maximum weight of 150kg can be carried completely safely and materials such as wood and foam can be secured to avoid chipping and slip-ping in areas of contact with the cart.
- Two hooks in the upper part of the cart support the Superstick frame to more easily coat tiles with adhesive glue and create movement continuity between the plate lifting phase and installation.



PLASTIC CORNER PROTECTOR FOR SINTERED STONE SLABS



Brevetti Montolit SpA

Australia

CDK Stone
Head Office
4-6 Freighter Road
Moorabbin VIC 3189

P: 03 8552 6000

blog: www.cdkstone.com.au/montolit
email: info@cdkstone.com.au
web: www.cdkstone.com.au

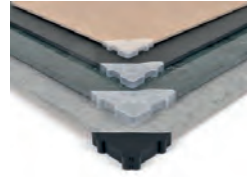

Reference: 300-95-04 (3/4mm)
300-95-06 (5/6mm)
300-95-10 (8/10mm)
300-95-12 (11/12mm)

Machinery: Plastic corner protector for Sintered Stone Slabs.

Features, Diameters, Observations:

- A set of large plastic tiles for Sintered Stone Slabs.
- A patented system that absorbs shocks which could damage or chip the material.
- Made of plastic material that can be re-used again and again.

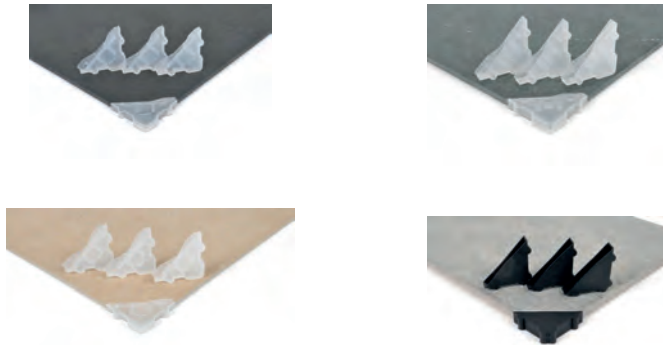

MASONRY WET SAW

FLEX
Das Original

FLEXAustralia

CDK Stone
Head Office
4-6 Freighter Road
Moorabbin VIC 3189

P: 03 8552 6000

email: info@cdkstone.com.au
web: www.cdkstone.com.au



Reference: CS60

Machinery: Wet Circular Saw

Features, Diameters, Observations:

Diamond masonry wet saw with GFCI.

- High-performance motor: extra powerful for stone cutting and joint milling
- Continuous cut depth setting from 0-60 mm, with rail guide up to 54 mm. In the mitre cut from 0-44 mm, with guide rail up to 38 mm
- Continuous angle adjustment for mitre cuts from 0-45°
- High-quality magnesium die-castings for protective cover and base plates
- Motor protection made of rubber prevents the direct intake of spray water
- Water supply: for an effective cooling of the diamond blade
- Quick-fit brass coupling: for 1/2" water hose
- GFCI operator protector circuit breaker: integrated in cord



DIAMOND BLADE

DIAREX[®]

Diarex

Australia

CDK Stone
Head Office
4-6 Freighter Road
Moorabbin VIC 3189

P: 03 8552 6000

email: info@cdkstone.com.au
web: www.cdkstone.com.au



Reference: DBT105US

Machinery: Diamond blade

Features, Diameters, Observations:

- The new standard of high quality Diarex blades for cutting Sintered Stone, Marble, Engineered Stone.
- New generation 10mm x 1.2mm segment ensures longer life & segment strength
- 105mm, 125mm
- 22.2mm bore
- Yellow



DIAMOND CORE-BITS FOR DRILLING

DIAREX[®]

DiarexAustralia

CDK Stone
Head Office
4-6 Freighter Road
Moorabbin VIC 3189

P: 03 8552 6000

email: info@cdkstone.com.au
web: www.cdkstone.com.au



Reference: DCD0##VDU

Machinery: Diamond Core-Bits for drilling
Features, Diameters, Observations:

- Use: wet
- Diarex Ultra Vacuum Brazed Core Drills with M14 Thread
- Material: For all types of Sintered Stone, terracotta tiles, granite and marble.
- Application: For furniture and bathroom fittings and electric and plumbing systems.
- Perfect for drilling: porcelain stoneware, hard ceramic, granite, marble
- Speed: Very High
- Finish: Good
- Lifespan: Good
- Use: Flexible angle grinder
- Diameter: 6mm, 8mm, 10mm, 12mm, 16mm, 20mm, 25mm, 30mm, 32mm, 35mm, 38mm, 40mm, 45mm, 50mm



DIAMOND HAND PADS

DIAREX[®]

Diarex

Australia

CDK Stone
Head Office
4-6 Freighter Road
Moorabbin VIC 3189

P: 03 8552 6000

email: info@cdkstone.com.au
web: www.cdkstone.com.au



Reference: DFHP90M0##0

Machinery: Diarex Diaflex Hand Pad 90x55mm -
Metal Bond Flat Foam Backing

Features, Diameters, Observations:

- Main purpose: Ideal for smoothing and finishing ceramic, glass and Sintered Stone tile corners and edges and marble and granite coverings. Excellent for smoothing and rounding sharp edges where tiles are cut to increase their mechanical strength.
- Instructions for use: Rub the pad on the surface to be treated, using the entire diamond surface so as to maximize service life.
- Characteristics: Made using a special diamond deposition technology, the pads come in two different diamond grain sizes to suit the material to be worked: – medium (DFHP90M0600), in green, for hard tile, porcelain tile, klinker and granite – fine (DFHP90M0200), in red, for single-fired tiles, double-fired tiles, terracotta, marble and glass.

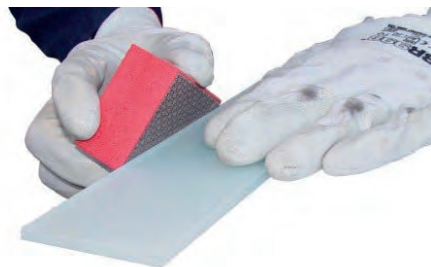

13. CLEANING PRODUCTS

HEAVY ORGANIC DIRT REMOVAL	
<p>Lithofin Premium Stone + Tile Care Products</p> <p>Lithofin WAX-OFF</p> <p>Removes layers of mineral oil, grease, silicone, resins, adhesives, sealant, lacquer, tar, grease and fresh paint. Rinses off with water.</p> <ul style="list-style-type: none"> • Ready-to-use • Dissolves surface dirt's • Deep acting • Contains solvents 	
Container	Ref. number
1ltr bottle	LFWAXOFF01

EXTERNAL GREEN DEPOSITS	
<p>Lithofin Premium Stone + Tile Care Products</p> <p>Lithofin ALGEX</p> <p>Special cleaner for outdoor areas removing algae, moss and slippery green deposits from steps, paths, terraces, walls, etc.</p> <p>Suitable for all external pavers, stone, concrete, brick, and plastic and wood furniture.</p> <ul style="list-style-type: none"> • Concentrate • Self-acting and preventive • Easy and safe to use • Free of chlorine and acid 	
Container	Ref. number
1ltr bottle	LFALGEX01

EPOXY GROUT



Lithofin Resin-EX

Removes residues of epoxy grout, brush-in systems, similar organic substances such as resins.

- Professional use product
- This product is NOT suitable for acid sensitive surfaces.



Container

1ltr bottle

Ref. number

LFRESINEX01

BATHROOM AND SANITARY AREAS



Lithofin KF Active-Clean

For regular cleaning of bathroom, toilet and sanitary areas, promoting hygienic cleanliness.

Removes lime scale, soap scum, body oils, rust and grease deposits from baths and showers. Cleans chrome, ceramics, glass, basins, grout lines, stainless steel etc.

- Concentrate - high yield
- Contains acid
- Self-acting



Container

1ltr bottle

Ref. number

LFKACTCLN01

Products for benchtops, sinks and shower trays

BENCHTOP CLEANING	
<p>Lithofin <small>Premium Stone + Tile Care Products</small></p> <p>Lithofin MN Easy-Clean</p> <p>Ideal for every-day cleaning of small stone surfaces such as kitchen benchtops, tabletops and bathroom vanities. Lithofin MN Easy-Clean leaves your surfaces hygienically clean, streak free; as well as enhancing the stones appearance.</p> <ul style="list-style-type: none"> • Ready to use • Cleans, protects and maintains • Streak-free finish • Safe-to-use in food preparation areas 	
Container	Ref. number
500ml bottle 1ltr bottle	LFMECLNS0.5 LFMECLNR01

Products for floors and facades

INTERNAL FLOOR CLEANING

Lithofin®

Premium Stone + Tile Care Products

Lithofin KF Vitra-Clean

For every-day cleaning of ceramic and porcelain floors subjected to normal levels of wear. Selected raw materials ensure an optimum, streak-free cleaning effect without building up layers. Surfaces become more attractive and less sensitive with continued use.

- Concentrate – very high yield
- Free of wax
- Mildly alkaline
- Does not form layers



Container

1ltr bottle

Ref. number

LFKVTCLN01

THOROUGH CLEANING

Lithofin®

Premium Stone + Tile Care Products

Lithofin KF Intensive Cleaner

For occasional thorough cleaning or for regular cleaning of floors subjected to heavy usage.

Removes stubborn and accumulated dirt, oil and grease films, care product residues from internal and external surfaces and grout lines.

Suitable for all ceramic and porcelains finishes.

- Concentrate
- Extra strong
- Alkaline
- Highly active



Container

1ltr bottle

Ref. number

LFKINTCLN01

NEWLY INSTALLED SURFACES

Lithofin®

Premium Stone + Tile Care Products

Lithofin KF Cement Residue Remover

Special product for removing grout residues and builders dirt from newly installed ceramic and porcelain tiles. Prepares surfaces for use.

Effortlessly removes cement-based grout residues, mortar, rust, lime, efflorescence and hardened dirt layers.

- Concentrate
- Acid-based
- Acts rapidly
- Low odour
- Easy to use



Container

1ltr bottle

Ref. number

LFKCRR01



SAFETY DATABASE

From all the available information about Neolith, The Size has prepared a Safety Data Sheet as specified in the REACH Regulation (EC) N° 1907/2006.

The purpose of this guide is to provide employees general information and guidance on how to handle the product during all activities, to promote and improve working conditions and to minimize potential risks through the implementation of the risk management measures proposed in this document.

Because of the product characteristics, employees should be aware that during cutting and/or polishing of Neolith, they may come in contact with breathable airborne crystalline silica (quartz). Prolonged or massive inhalation of breathable crystalline silica may cause pulmonary fibrosis, commonly known as silicosis. The main symptoms include coughing and difficulty breathing. Therefore TheSize recommends wet cutting and polishing to reduce the exposure to breathable crystalline silica dust to a minimum.

According to Regulation (EC) N° 1907/2006 Version 2 Print date 21.12.2011 Revision date 21.12.2012, the finished product (porcelain tile) presents no risk to human health and the environment. Because of generation of silica dust in the dry manipulation processes the following risks must be taken into account:

Regulation CLP CE N° 1272/2008 Crystalline silica dust	Classification according Directive 1999/45/CE
<p>Precautionary statements</p> 	
<p>P260: Do not breathe dust generated in the cutting, shaping and polishing of the material.</p> <p>P264: Wash hands and face thoroughly after handling</p> <p>P270: Do not eat, drink or smoke when manipulating</p> <p>P280: Wear gloves, suitable work clothing and goggles</p> <p>P284: Wear respiratory protection for particles (P3)</p> <p>P314: Consult doctor if feeling unwell</p> <p>P501 Remove residues in accordance with local regulations</p>	<p>R20: Harmful by inhalation</p> <p>R48: Danger of serious damage to health by prolonged exposure</p> <p>S22: Do not breathe dust</p> <p>S38: In case of insufficient ventilation wear suitable respiratory equipment (P3)</p>

Safety Guidelines

101

Additional Information:

According to information provided, the testing of the product has not detected or cristobalite or tridymite, which are the more siliceous and dangerous varieties.

More detailed information regarding safety and health standards and recommendations is available on www.neolith.com (Downloads: Safety Data Sheets section).



NEOLITH[®]
SINTERED STONE

4-6 Freighter Road
Moorabbin VIC 3189
www.neolith.com.au

Marketed by:

cdk

CDK STONE
cdkstone.com.au